

ASSEMBLY, MAINTENANCE, & **USER MANUAL**

MODEL #LMG-SPTCS1515

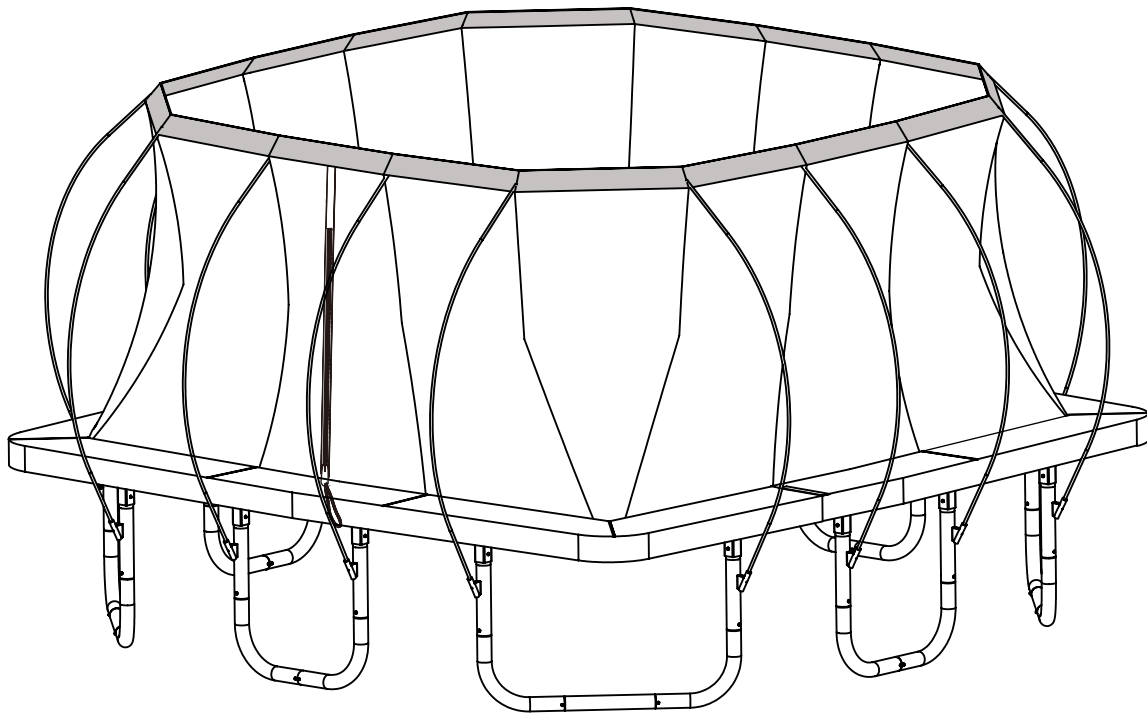

WARNING

Read all precautions and instructions in this manual before using this equipment. Save this manual for future reference.

Maximum user weight 600 lbs.

SKYWALKER

TRAMPOLINES

Skywalker Holdings LLC
P.O. Box 574, Brigham City, UT 84302

TABLE OF CONTENTS

Part List.....	3
Part Identification.....	4-6
Exploded Drawing.....	7
Assembly.....	8-21
Maintenance and Care Information.....	22
Instructions for Use.....	23
Warning Label Placement.....	24
Instructions and Model Lessons.....	26-27
Trampoline Safety Information.....	28
Enclosure Safety Information.....	29
Methods of Accident Prevention.....	30
Limited Warranty.....	31



STOP EVERYTHING YOU'RE DOING AND REGISTER YOUR TRAMPOLINE

Find our warranty registration online by typing in: www.skywalkertrampolines.com/registration/

You'll need to have the following information handy:

- Name
- Address
- Phone number
- Date of purchase
- Email address
- Trampoline model number
- Trampoline serial number
- Retailer the trampoline was purchased from

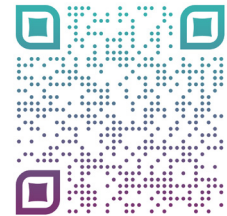

HEY WE'VE GOT SOMETHING REALLY IMPORTANT TO SAY

Skywalker Trampolines belongs to a family of brands focused on providing active products. Check us out online! We've got **assembly videos** (for those of you who prefer movies over books), **FAQs** (so you know you're not the only one who asked a question), **additional products** (including fitness, sports, playground equipment, and trampolines), and most importantly, find us on social media! Because we want to be your friend. **We'd love to hear from you, friend.**



@skywalkertrampolines



skywalkertrampolines



@skywalker_trampolines



@swtrampolines



@swtrampolines



www.skywalkertrampolines.com



@skywalkertrampolines

IMPORTANT

Trampolines and enclosures are susceptible to winds. Be sure to secure your trampoline and enclosure. Wind damage is not covered in the warranty of your trampoline.

WARNING

CHOKING HAZARD- Small parts not for children under 3 years.

WARNING

Adult assembly required.

PART LIST

Key No.	Qty.	Description	Key No.	Qty.	Description
1	4	Corner Tube	20	32	M10 Nut
2	8	Straight Tube	21	16	M6x75mm Bolt
3	4	Curved Tube	22	96	M6 Washer
4	16	T-Joint	23	48	M6 Nut
5	16	Leg	24	32	M6x85mm Bolt
6	16	Leg Post with Socket	25	16	End Cap (pre-installed)
7	4	Center Leg Extension	26	2	Wrench
8	4	Center Leg Sleeve	27	1	Spring Tool
9	1	Mat	#	1	User Manual & Safety Placard
10	1	Enclosure Net	#	1	Set of ASTM Frame Labels
11	92	Spring			
12	2	Pad			
13	20	Strap			
14	16	Lower Enclosure Flex Rod			
15	16	Upper Enclosure Flex Rod			
16	16	Connect Tube			
17	32	M10X95mm Bolt			
18	32	M10 Arc Washer			
19	32	M10 Spring Lock Washer			

ORDERING REPLACEMENT PARTS

We get it, sometimes things happen. But the fun shouldn't stop just because you need a new bolt or screw! To order replacement parts, check out our website at: www.skywalkertrampolines.com or call our toll-free Customer Care Hot-line at **1-866-603-Jump (5867)**, Monday - Thursday, 8 a.m. until 5 p.m. and Friday, 8 a.m. until 3 p.m. Mountain Time (excluding holidays).

Our customer service team will ask you a few questions in order to get the replacement part sent out as soon as possible. We're not trying to complicate your life, we promise.

When calling, make sure to have the following information ready:

- The model # of the product (see the front cover of this manual)
- The key # and description of the part (see the part list above)
- The quantity needed (only you know the answer to that one!)

BEFORE YOU BEGIN

Thanks for choosing Skywalker Trampolines! We're just as excited as you are to help your family live an active (but most importantly **FUN**) lifestyle. This model is one of our favorites, and we're confident you'll love it too. To make things easier for you, we've listed important information that you (and your little outdoor adventurers) need to know. Make sure you brush up on the warnings, instructions, assembly, maintenance, and use of your new product because there will be a pop quiz at the end! (Okay, not **REALLY**, but if you're still reading this, props to you! You're awesome).

PART IDENTIFICATION

Before you begin, take a look at the drawings below to make sure you have all the parts! The numbers in the squares to the left (key numbers) will help you identify the parts during assembly.

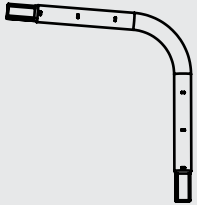

1 Corner Tube (x4)



2 Straight Tube (x8)

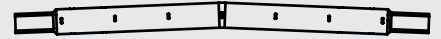

3 Curved Tube (x4)

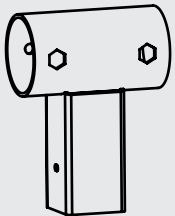

4 T-Joint (x16)

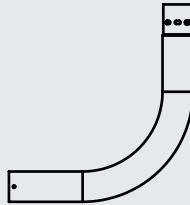

5 Leg (x16)

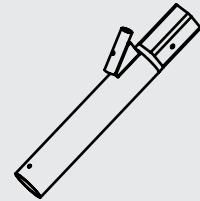

6 Leg Post with socket (x16)

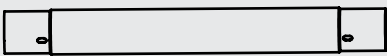

7 Center Leg Extension (x4)

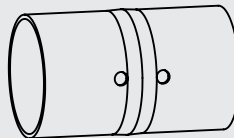

8 Center Leg Sleeve (x4)

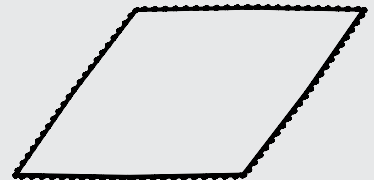

9 Mat (x1)

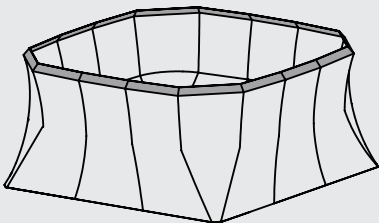

10 Enclosure Net (x1)



11 Spring (x92)

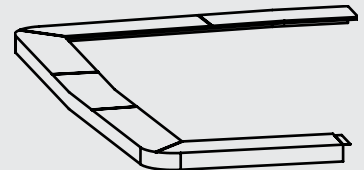

12 Pad (x2)



13 Strap (x20)

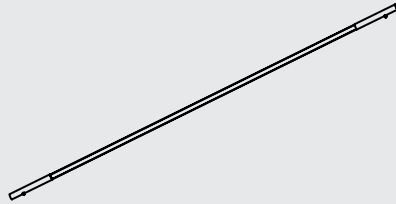

14 Lower Enclosure Flex Rod (x16)

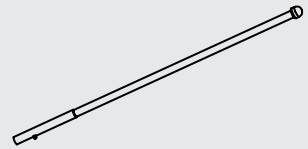

15 Upper Enclosure Flex Rod (x16)

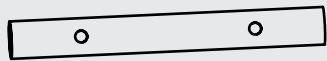

16 Connect Tube (x16)

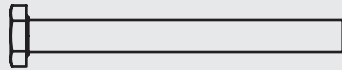

17 M10X95mm Bolt (x32)



18 M10 Arc Washer (x32)

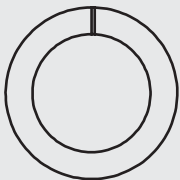

19 M10 Spring Lock Washer (x32)

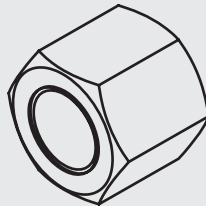

20 M10 Nut (x32)

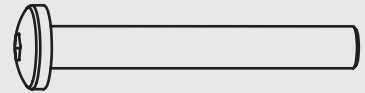

21 M6x75mm Bolt (x16)

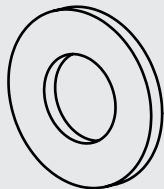

22 M6 Washer (x96)

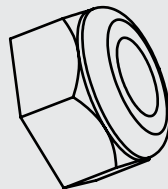

23 M6 Nut (x48)



24 M6x85mm Bolt (x32)

PART IDENTIFICATION

Before you begin, take a look at the drawings below to make sure you have all the parts! The numbers in the squares to the left (key numbers) will help you identify the parts during assembly.

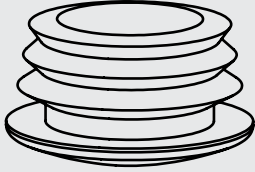

25 End Cap (x16)
(pre-installed)

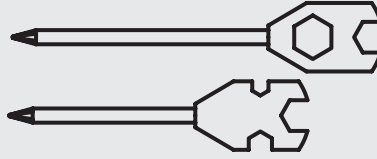

26 Wrench (x2)

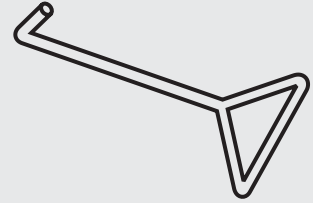

27 Spring Tool (x1)

EXPLODED DRAWING

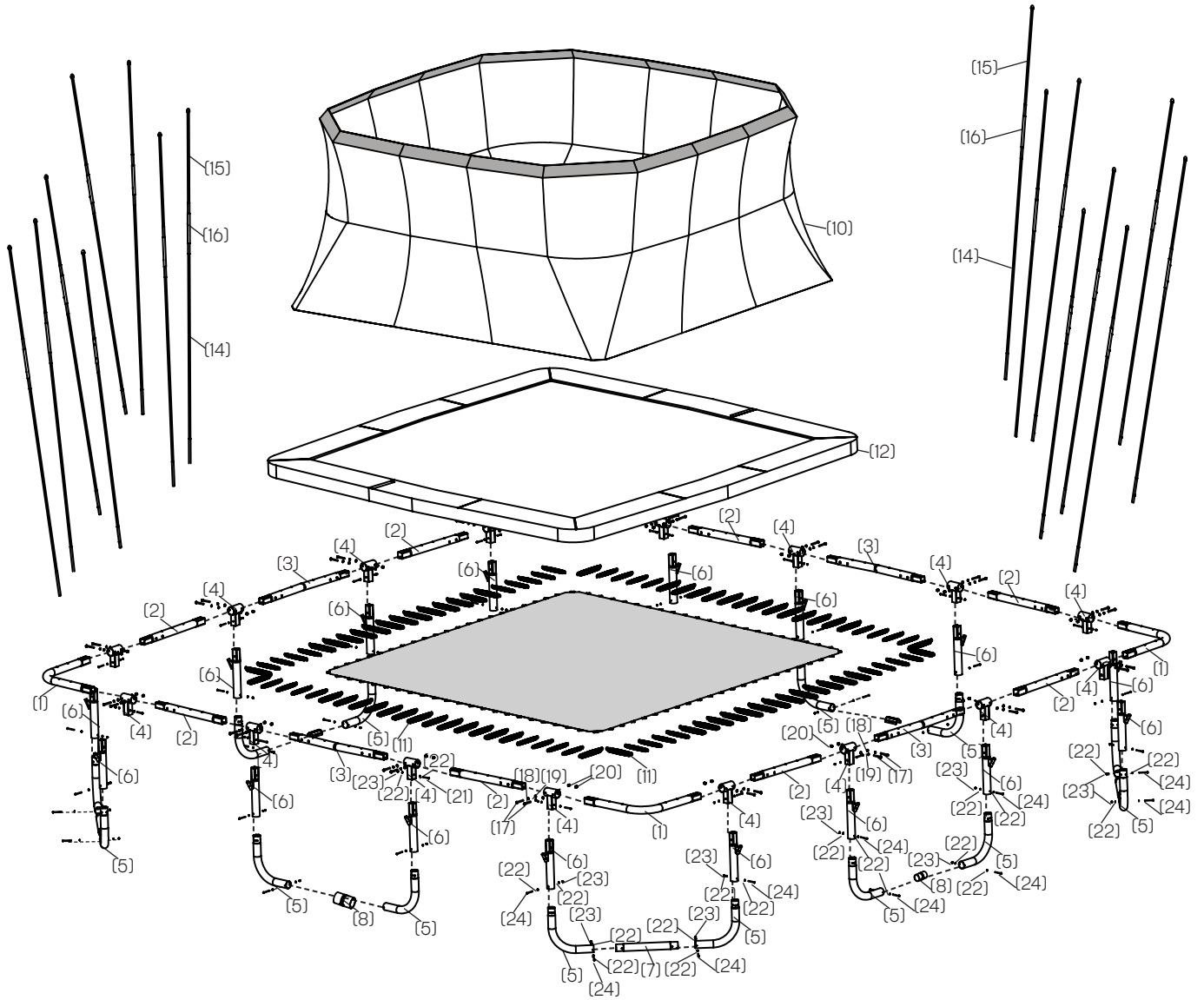

ASSEMBLY

READ THIS BEFORE YOU BEGIN

- **You will need at least 2 adults and several hours to assemble your trampoline** (of course, that depends on what model you have, and whether or not you're secretly a superhero).
- We've provided a Phillip's screw driver and two adjustable wrenches to help with assembly, but you're more than welcome to use your own tools. Many find that using a power drill and a rubber mallet makes things easier.
- Use gloves to protect your hands from pinch points during assembly. Plus, it's an up-and-coming fashion trend.
- The assembly steps refer to parts by their descriptions and key numbers (see the part list on page 3).
- The assembly steps are written in a specific order, and if you don't follow them exactly, you may end up having to start all over again.
- Most importantly, **YOU'VE GOT THIS. YOU'RE THE BEST TRAMPOLINE ASSEMBLER AROUND.** This may not be the easiest thing you've ever done, but it will be **worth it.** Trust us.

And if you're a visual learner, check out our assembly videos!



skywalkertrampolines

STEP 1

Register your trampoline! For info on **warranty registration**, see page 2.

STEP 2

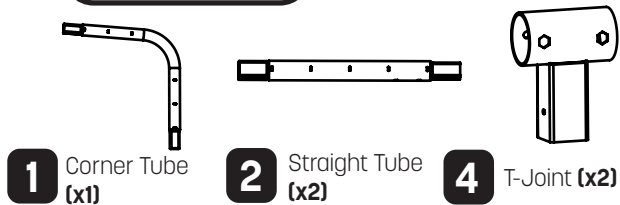

Assemble this trampoline where it will be used as it is a heavy product and will be difficult to move once fully assembled.

Place a corner tube **(1)**, two straight tubes **(2)** and two T-joints **(4)** on the ground as shown. Make sure the spring holes of the straight tubes are facing the ground. Slide the T-joints onto the straight tubes then slide the straight tubes into the corner tubes.

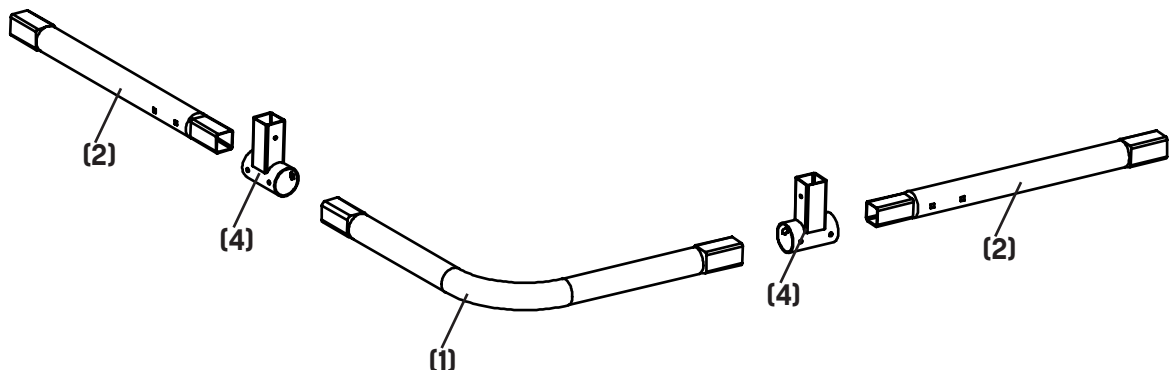

STEP 3



17 M10x95mm Bolt (x4)



18 M10 Arc Washer (x4)

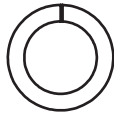

19 M10 Spring Lock Washer (x4)

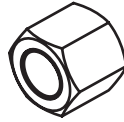

20 M10 Nut (x4)

Now line up the holes on the T-joints and straight tubes. Secure together using four M10x95mm bolts (17), four M10 arc washers (18), four M10 spring lock washers (19), four M10 nuts (20). Repeat steps 2-3 to assemble three additional corner frame sections.

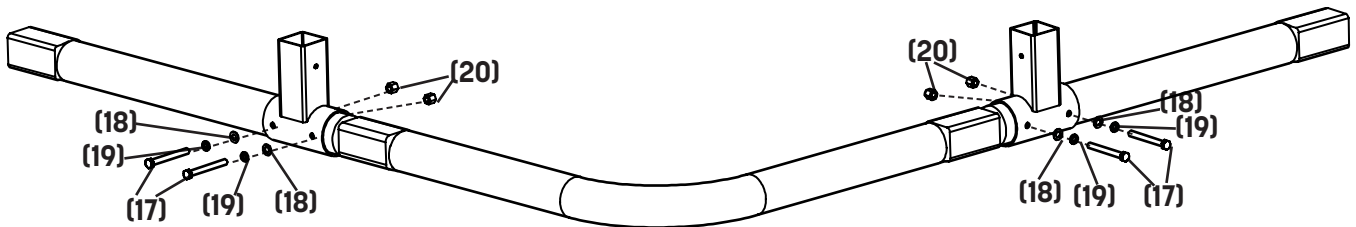

STEP 4

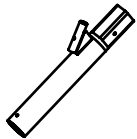

6 Leg Post with socket (x2)

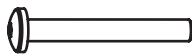

21 M6x75mm Bolt (x2)

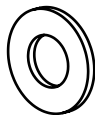

22 M6 Washer (x4)



23 M6 Nut (x2)

Insert two leg posts (6) into the T-joints (sockets facing out), and secure using two M6x75mm bolts (21), four M6 washers (22) and two M6 nuts (23). Repeat this step until all 8 leg posts are assembled.

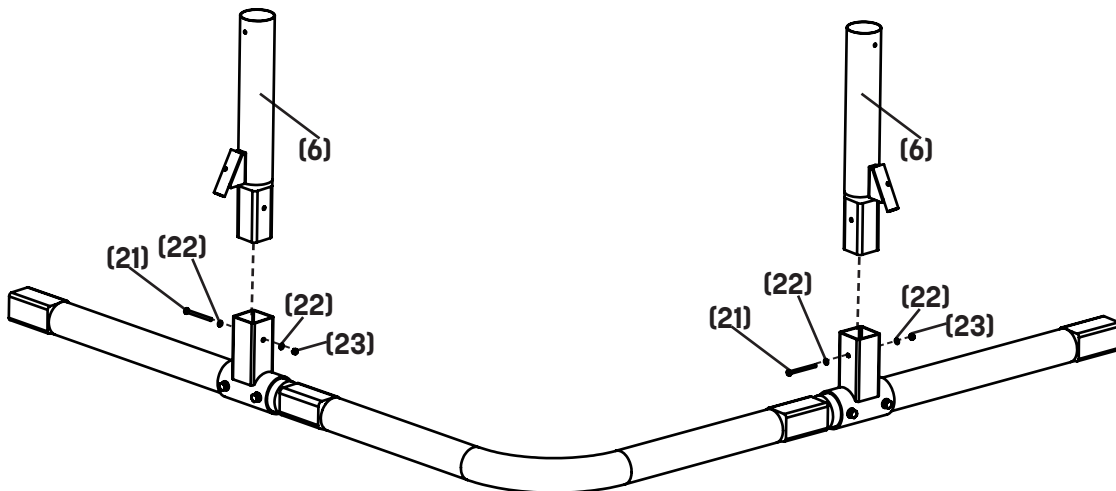

ASSEMBLY

STEP 5

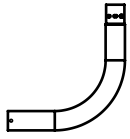

5 Leg (x2)

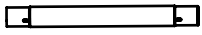

7 Center Leg Extension (x1)

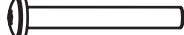

24 M6x85mm Bolt (x2)



22 M6 Washer (x4)



23 M6 Nut (x2)

Place the female side of one leg **(5)** section onto a center leg extension **(7)** section. Secure with one M6x85mm bolt **(24)**, two M6 washers **(22)**, and one M6 nut **(23)**. Place another leg **(5)** onto the other side of the center leg extension **(7)**. Secure with one M6x85mm bolt **(24)**, two M6 washers **(22)** and one M6 nut **(23)**. **Repeat this step until you have four U-shaped leg sections.**

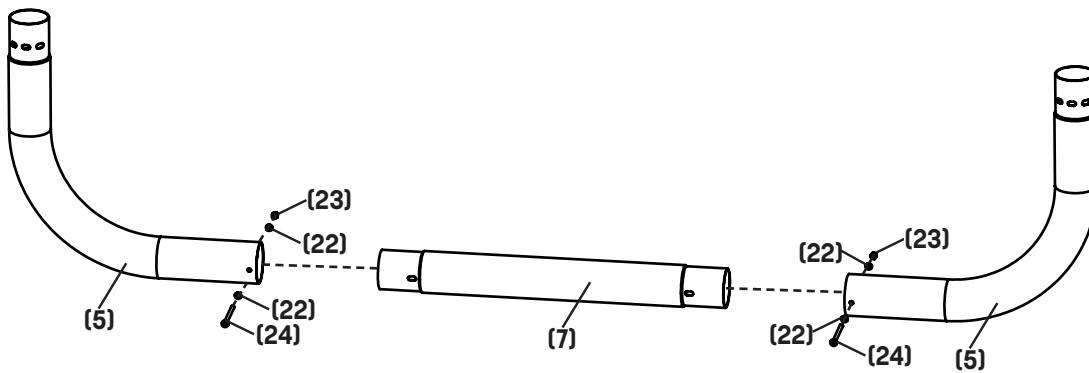

STEP 6

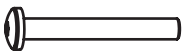

24 M6x85mm Bolt (x2)

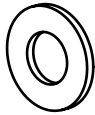

22 M6 Washer (x4)

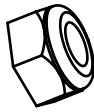

23 M6 Nut (x2)

Insert one U-shaped leg section into the leg posts of a corner frame piece. **Make sure the holes of the U-leg match the holes of the leg posts.** You may need to try more than one U-leg to find a correct fit. Secure with two M6x85mm bolts **(24)**, four M6 washers **(22)**, and two M6 nuts **(23)**. **Repeat this step until four corner leg sections are assembled. Remember to make sure the holes line up.**

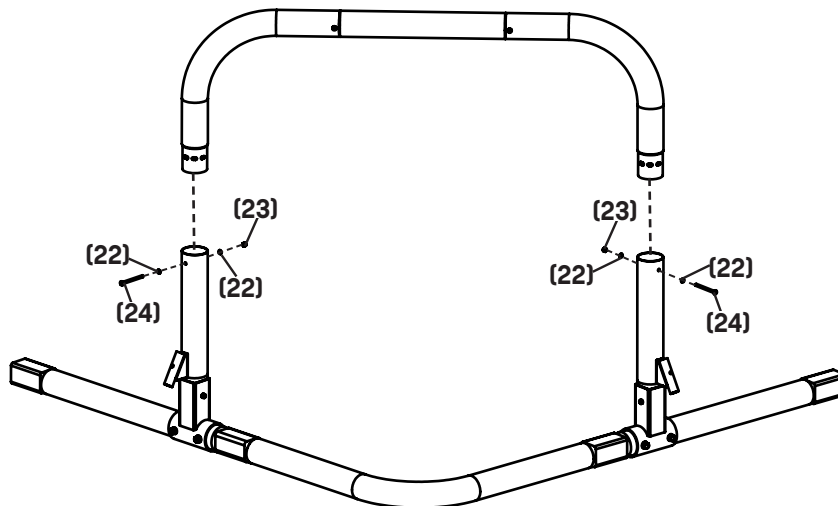

STEP 7



3 Curved Tube
(x1)



17 M10x95mm Bolt
(x4)



18 M10 Arc Washer
(x4)

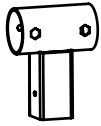

4 T-Joint
(x2)

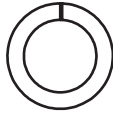

19 M10 Spring Lock Washer
(x4)

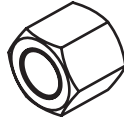

20 M10 Nut
(x4)

Place a curved tube **(3)**, and two T-joints **(4)** on the ground as shown. **Make sure the spring holes of the curved tubes are facing the ground and the bend of the curved tube is facing out.** Place the T-joints onto the end of each tube and line up the holes. Secure in place using four M10x95mm bolts **(17)**, four M10 spring lock washers **(19)**, four M10 arc washers **(18)**, and four M10 nuts **(20)**. **Repeat this step until 4 middle segments are complete.**

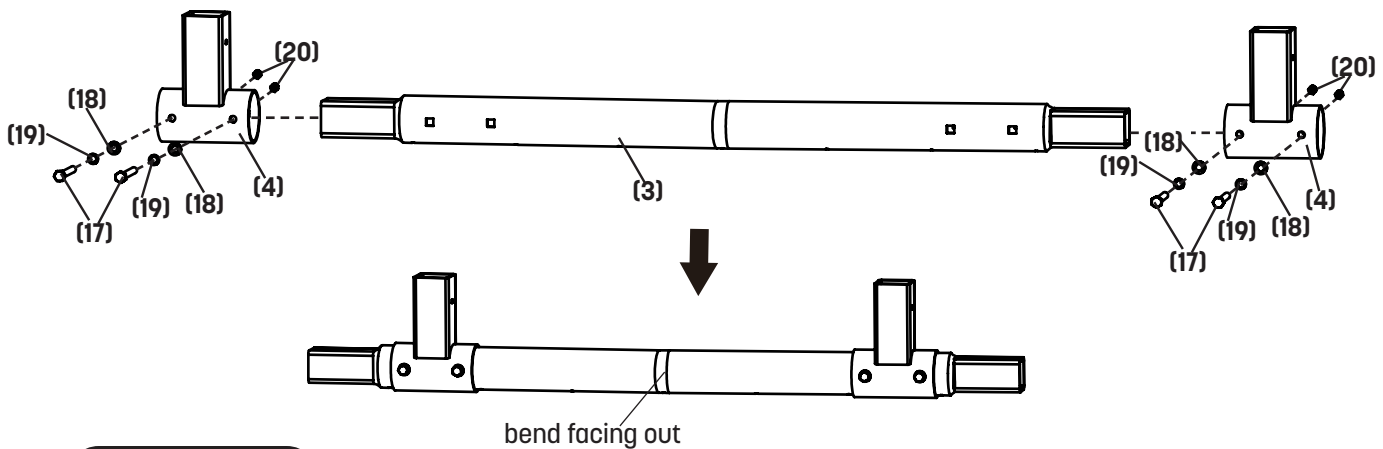

STEP 8

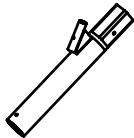

6 Leg Post with socket
(x2)

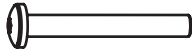

21 M6x75mm Bolt
(x2)

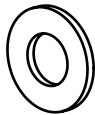

22 M6 Washer
(x4)



23 M6 Nut
(x2)

Now insert two leg posts with sockets **(6)** into the T-Joints of the middle segments **(sockets facing out.)** Secure using two M6x75mm bolts **(21)**, four M6 washers **(22)** and two M6 nuts **(23)**. **Repeat this step until the remaining leg posts are assembled.**

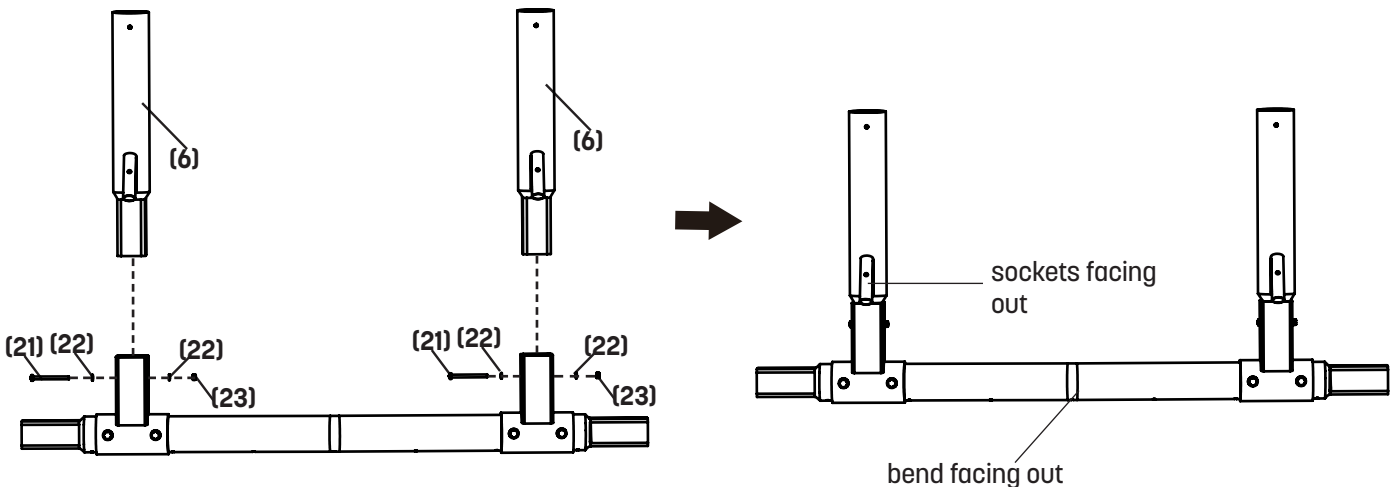

ASSEMBLY

STEP 9



5 Leg (x2)

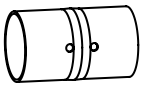

8 Center Leg Sleeve (x1)

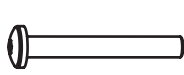

24 M6x85mm Bolt (x2)



22 M6 Washer (x4)

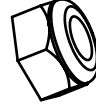

23 M6 Nut (x2)

Insert a center leg sleeve (**8**) inside the female side of one leg (**5**) section. Secure in place with one M6x85mm bolt (**24**), two M6 washers (**22**), and one M6 nut (**23**). On the other side of the center leg sleeve (**8**) attach a second leg (**5**). Secure with one M6x85mm bolt (**24**), two M6 washers (**22**), and one M6 nut (**23**). **Repeat this step until you have four middle U-shaped leg sections.**

! Be careful that you do not pinch your hand as you install the center leg sleeve.

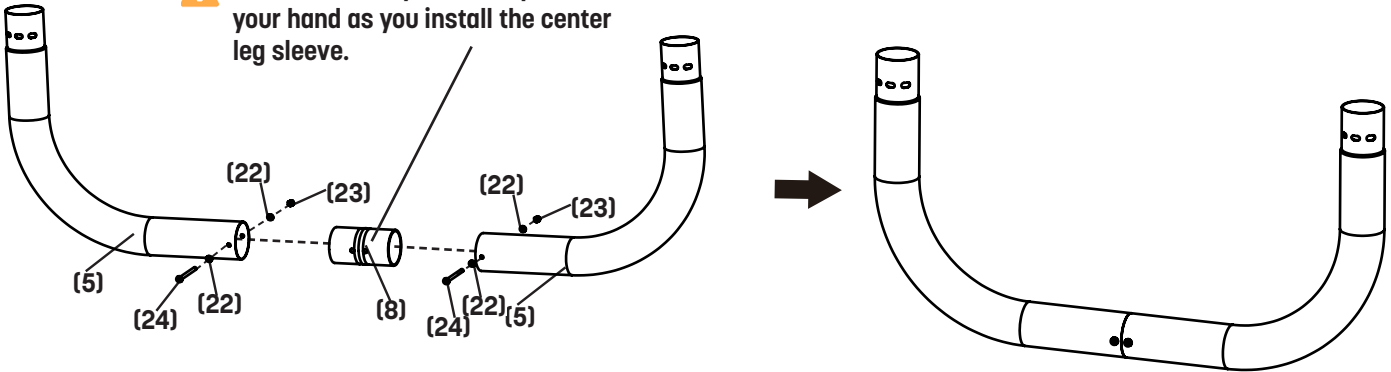

STEP 10

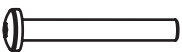

24 M6x85mm Bolt (x2)

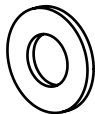

22 M6 Washer (x4)

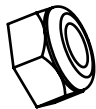

23 M6 Nut (x2)

Insert one U-shaped leg section into the leg posts frame piece. **Make sure the holes of the U-leg match the holes of the leg posts.** You may need to try more than one U-leg to find a correct fit. Secure with two M6x85mm bolts (**24**), four M6 washers (**22**), and two M6 nuts (**23**). **Repeat this step until four leg post sections are assembled. Remember to make sure the holes line up.**

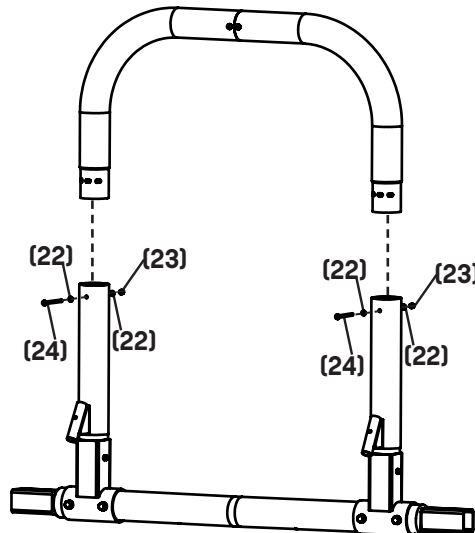

STEP 11

Grab a friend and flip the assembled corner leg sections over so they are now standing on the legs. **(Do not skip this step! We're not underestimating your strength or anything, but if you connect before flipping, the entire frame will be too heavy to flip.)** Now place a middle U shaped leg segment **(bend and sockets facing out)** in between two corner leg sections and slide them together. Repeat on the other side. You will now have two square frame halves assembled.

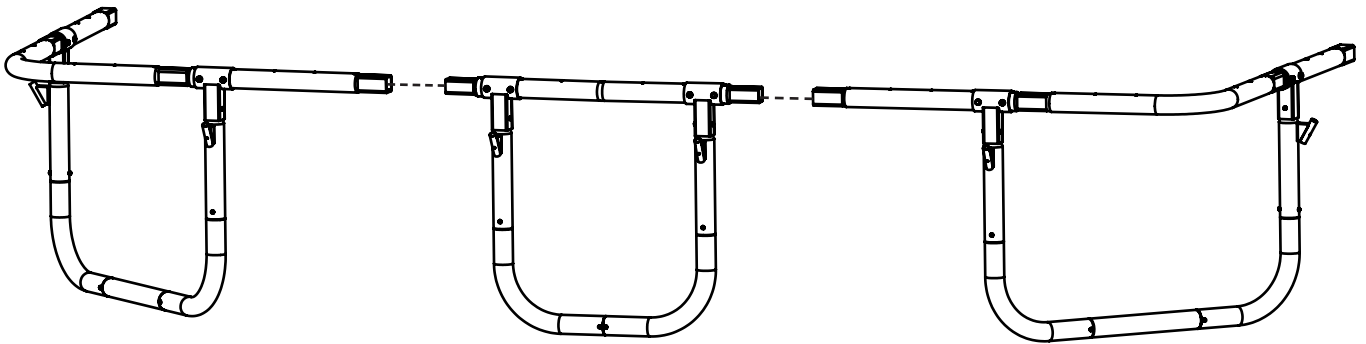

STEP 12

Now, place two middle U shaped leg segments **(bend and sockets facing out)** between the two frame halves. Slide the the trampoline together in a clockwise pattern to create a free standing frame.

Note: Tighten all the bolts to secure into place

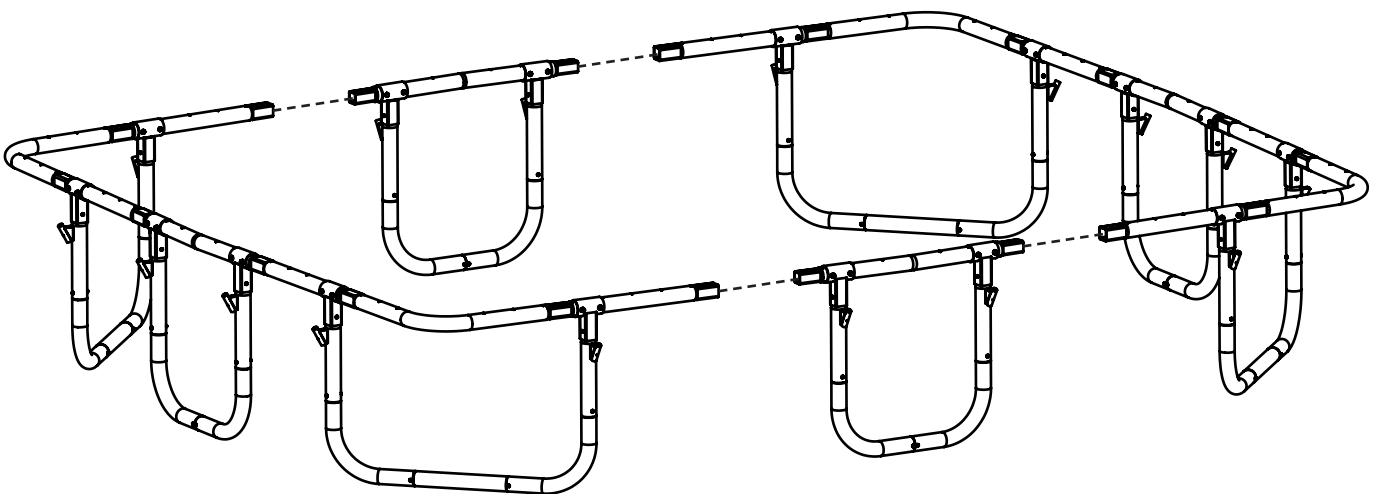

ASSEMBLY

STEP 13

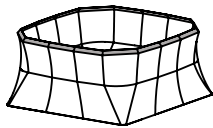

9 Mat (x1)

10 Enclosure Net (x1)

The enclosure net **(10)** will be pre-installed to the jump mat **(9)**. Before continuing, make sure each V-ring of the jump mat is properly threaded through the corresponding hole in the enclosure net.

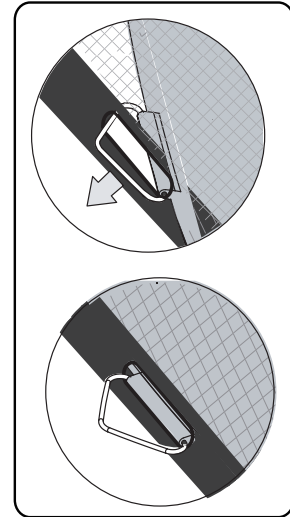
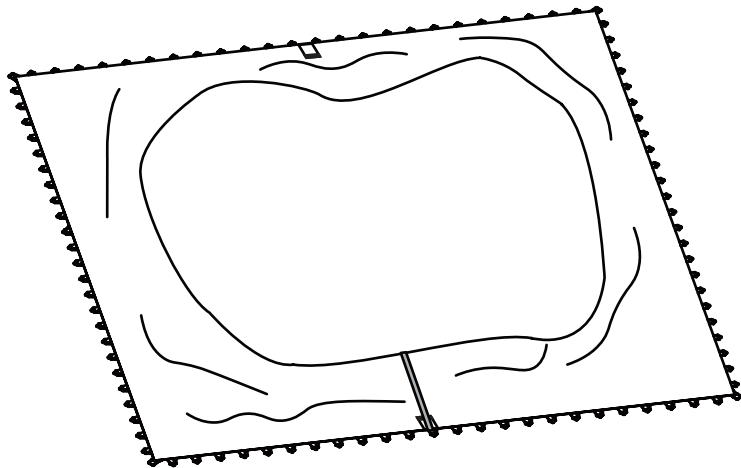

STEP 14

Place the jump mat on the ground inside the frame with the enclosure net on top. Lay it so the jump mat lines up with the frame. Be sure to center the enclosure door on the middle of one side.

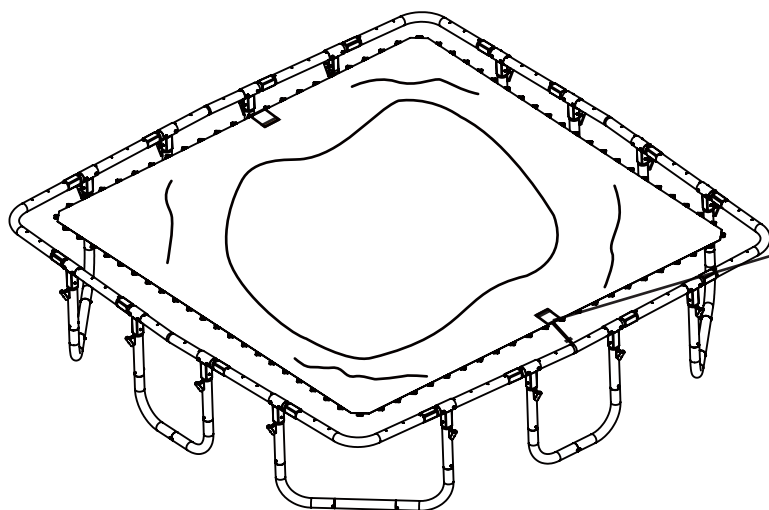

Enclosure door

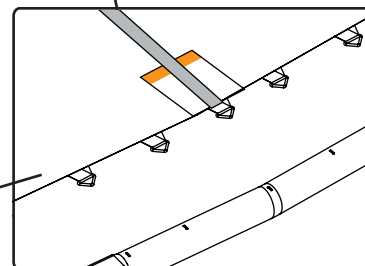

STEP 15



11 Spring
(x2)

27 Spring Tool (x1)

You may want to use gloves for this step! Using the spring tool (27), hook the smaller end of a spring (11) into a corner square ring of the jump mat. Stretch the free end of the spring until it reaches the nearest frame hole in the corner. Place another spring into the same corner square ring and stretch to the nearest frame hole on the other side of the corner. **Note: Because this is a premium trampoline, the springs will be difficult to stretch. Ask a friend to help!**

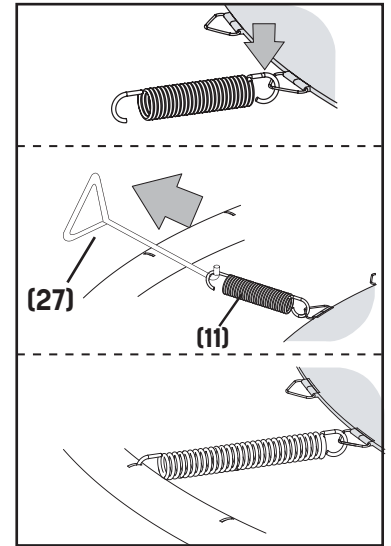
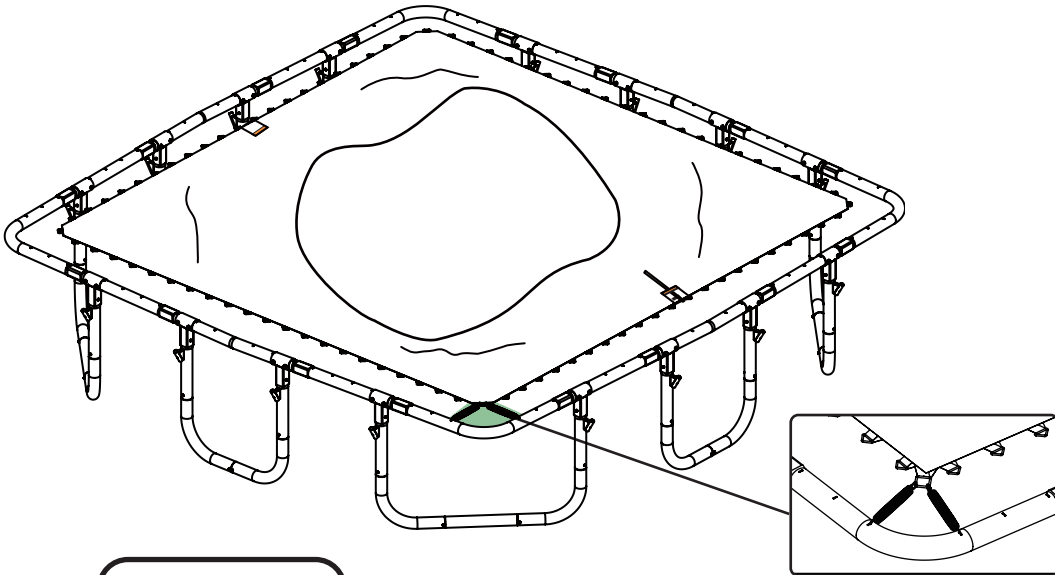

STEP 16



11 Spring (x22)

Repeat step 15 to attach **two** more springs to all of the remaining corners. You now should have **eight** springs attached, **two** in each corner.

Next, attach **four** springs to **four** V-rings (**two on each side of the corner**) and stretch to the spring holes on either side of the previously placed springs. Repeat this step on the three remaining corners. You now should have **24** springs attached.

Note: Be sure you are lining up the correct V-rings and frame holes!

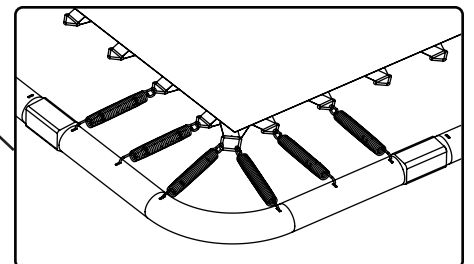
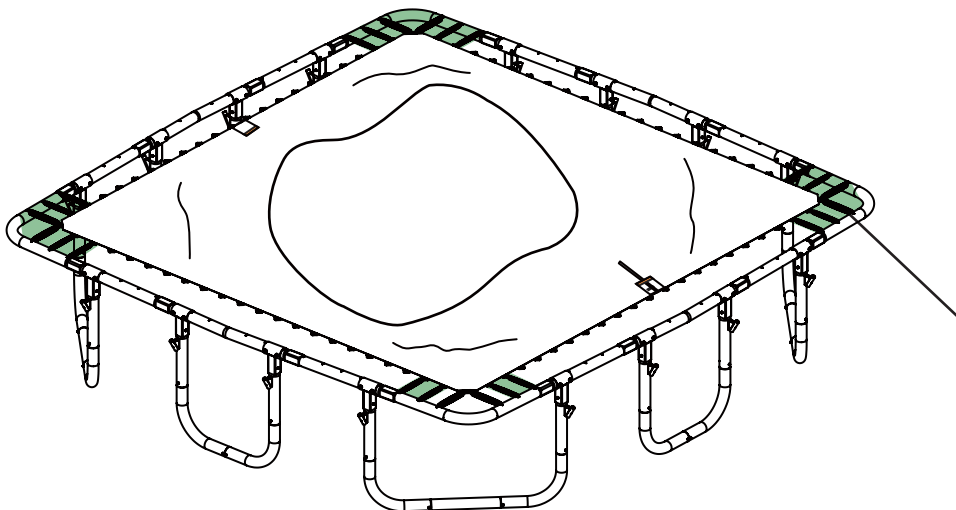

ASSEMBLY

STEP 17



11 Spring (x20)

Place **five** springs in the middle of one curved tube. To make sure the V-rings and frame holes line up properly, count the number of frame holes starting from a corner and moving towards the middle curved tube. Then, count the V-rings starting from the same corner to the exact number of spring holes and place the springs. **Repeat this step on each side to place a total of 20 additional springs.**

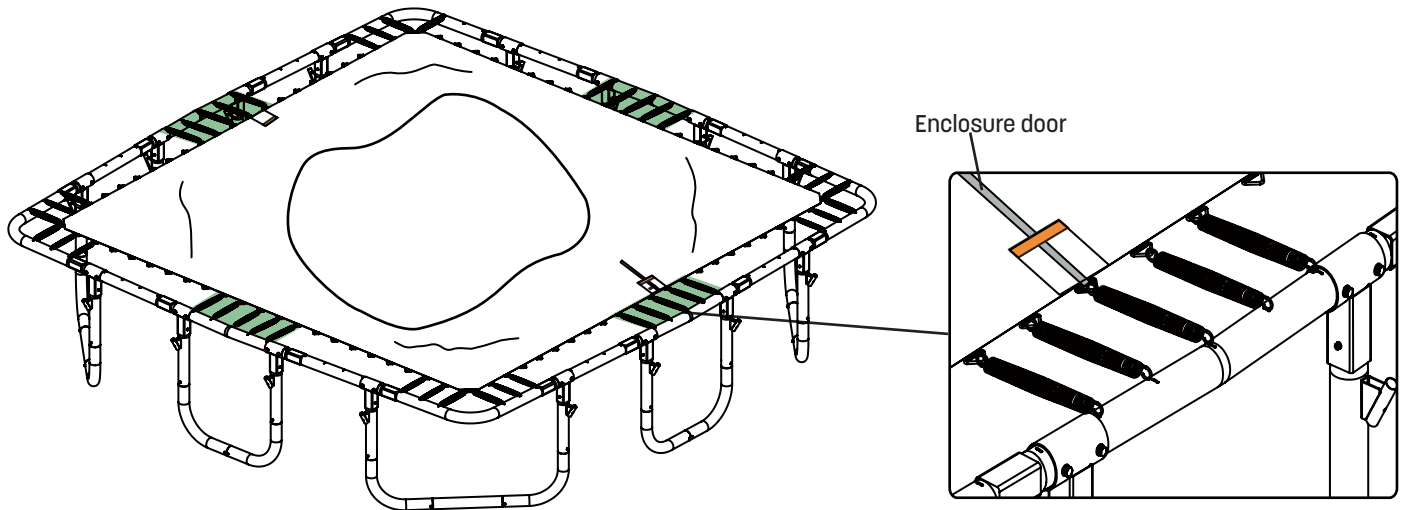

STEP 18



11 Spring (x16)

Next, attach **four** additional springs next to each corner by placing them on either side of the sockets. You will have attached 16 more springs (**four** on each side).

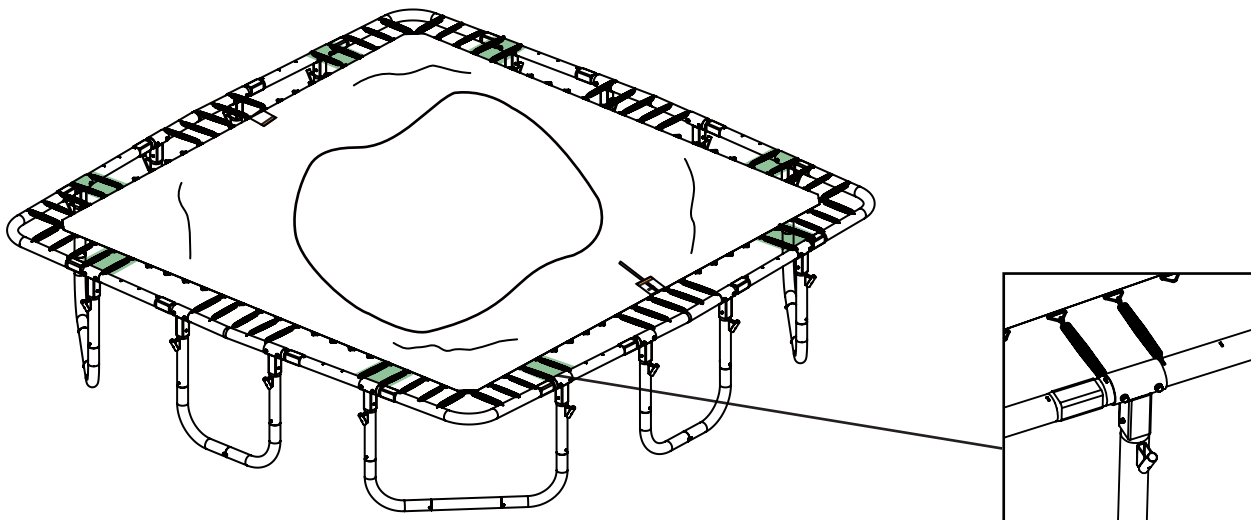

STEP 19



11 Spring (x32)

Now, working in a clockwise direction, attach all of the remaining springs. Make sure the V-rings and frame holes line up correctly.

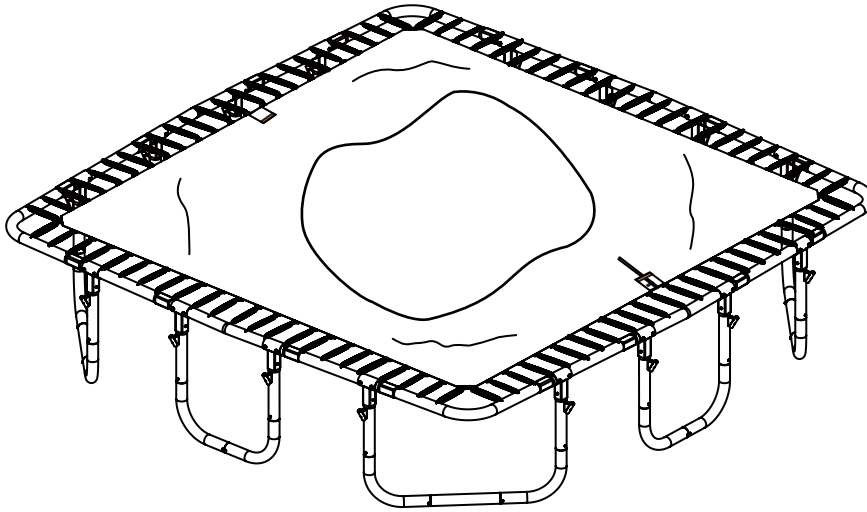

STEP 20

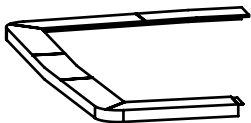

12 Pad (x2)

Lay the two halves of the frame pad **(12)** on the frame with the chosen color facing up. Then, connect the two pieces of padding together with the velcro. Make sure to line up the logo on the doormat section with the enclosure door

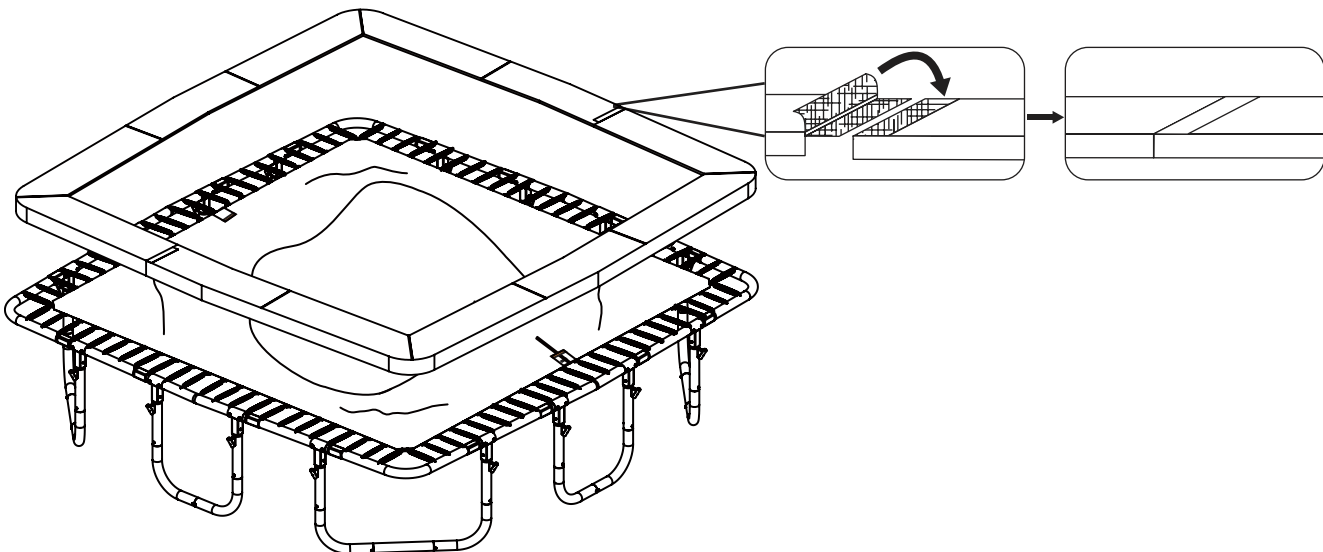

ASSEMBLY

STEP 21



13 Strap (x20)

To secure the spring pad to the trampoline, insert the provided straps **(13)** into the loops on the bottom of the pad (the side facing the springs). Thread the inside straps through the V-rings on the jump mat and place the outer straps on either side of the frame. Now tie all of the straps in bows. (Because if you tie them in knots, you'll have a pretty hard time untying them ever again!) Secure the corners of the spring pad to the frame using the attached straps. Hook the straps to the square rings at each corner.

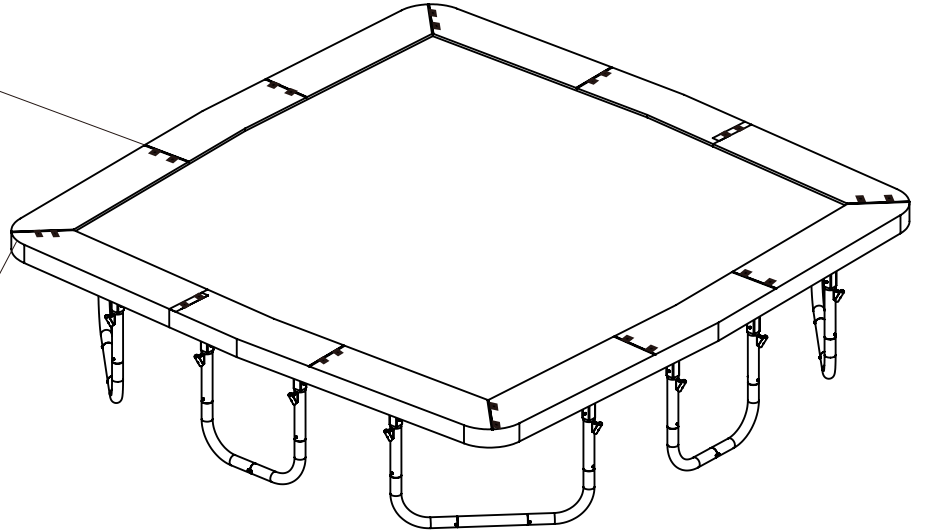
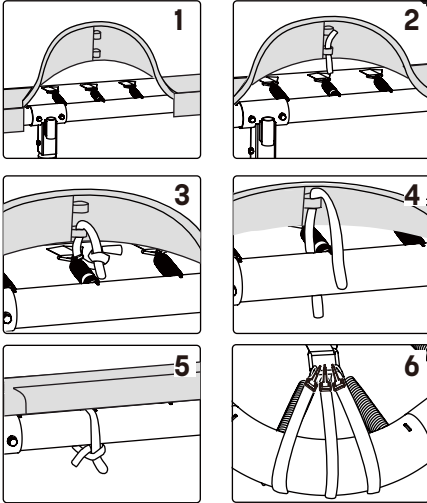

STEP 22

Look under the trampoline. Find the straps that are attached in between the two layers of the frame pad **(12)**. Position the straps on either side of the frame and tie the straps into bows.

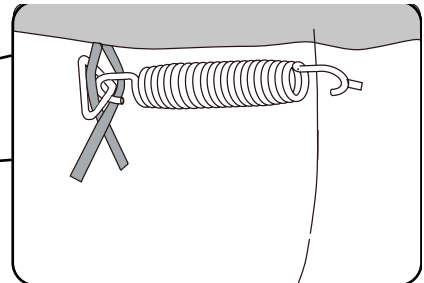
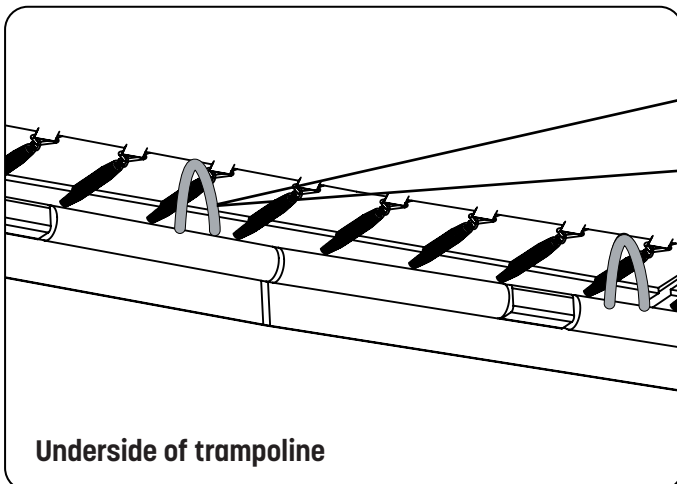

STEP 23

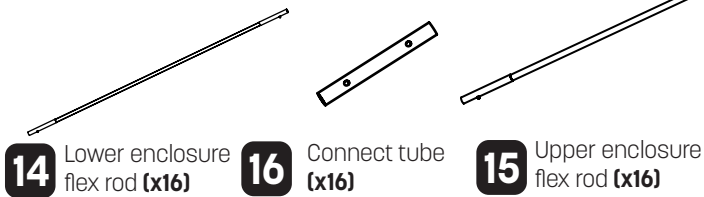

Connect the lower enclosure flex rod **(14)**, connect tube **(16)**, and upper enclosure flex rod **(15)** together, as shown, to make one complete enclosure rod.

Repeat this step to connect the remaining upper flex rods, connect tubes, and lower flex rods to complete a total of 16 enclosure rods.

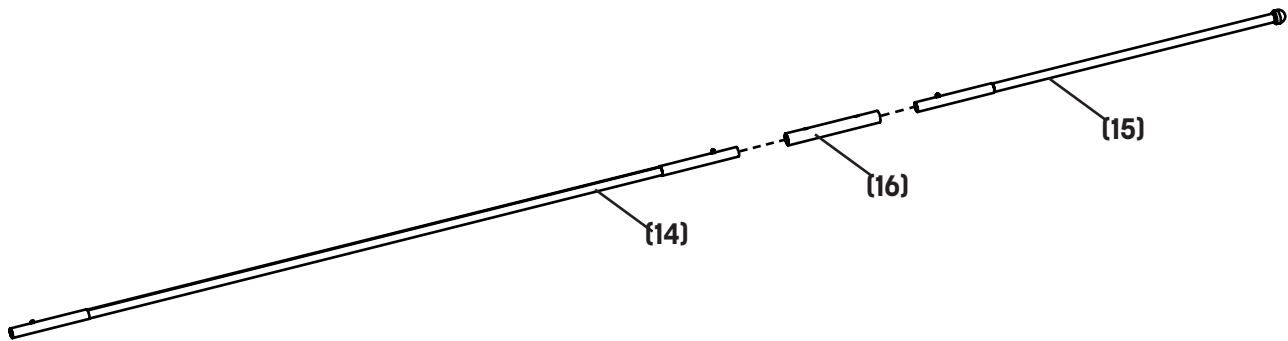

STEP 24

Insert the top end of a completed enclosure rod into a sleeve at the top of the enclosure net **(10)**. Repeat this step to place the remaining enclosure rods into the straps and sleeves.

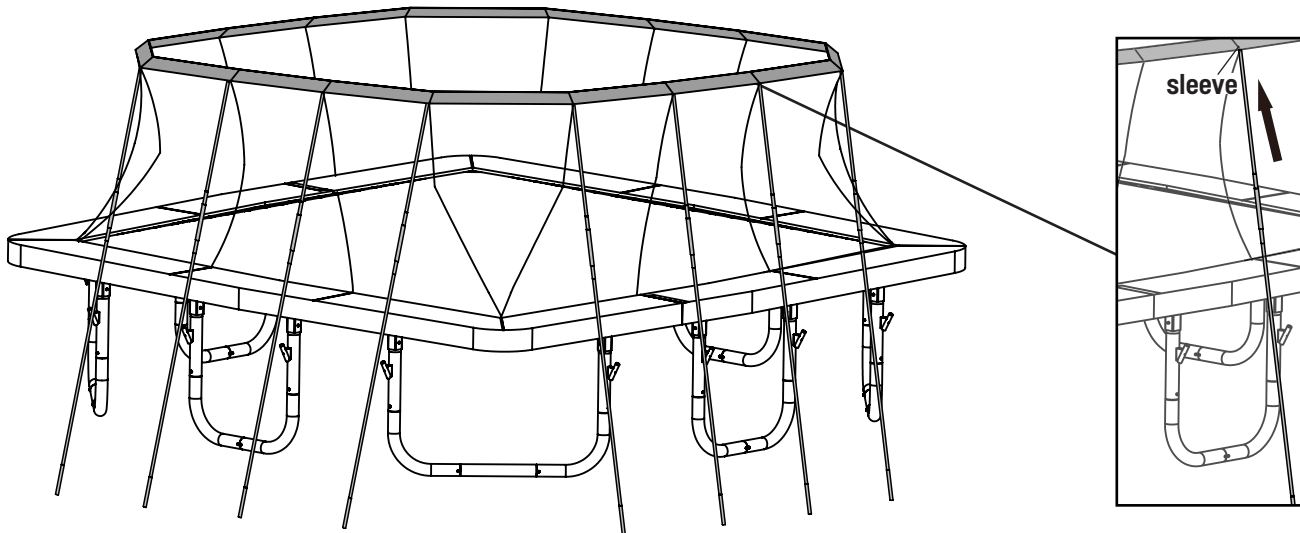

ASSEMBLY

STEP 25

Starting from the enclosure door, lift and insert the bottom of the enclosure rod into the bracket on the leg upright (1) (make sure the push pin is facing out so it can easily pop into place) Continue in a clock-wise direction, placing every other enclosure rod until all enclosure rods have been placed.

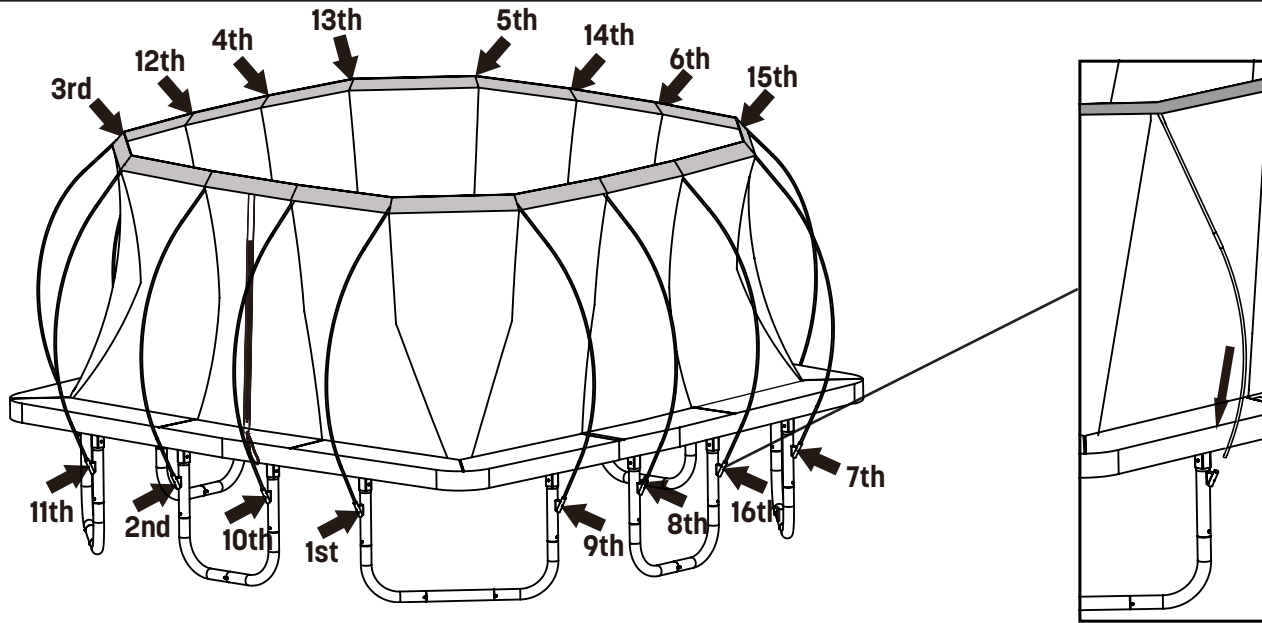

STEP 26

Tie the included placard to a socket close to the enclosure door as shown.

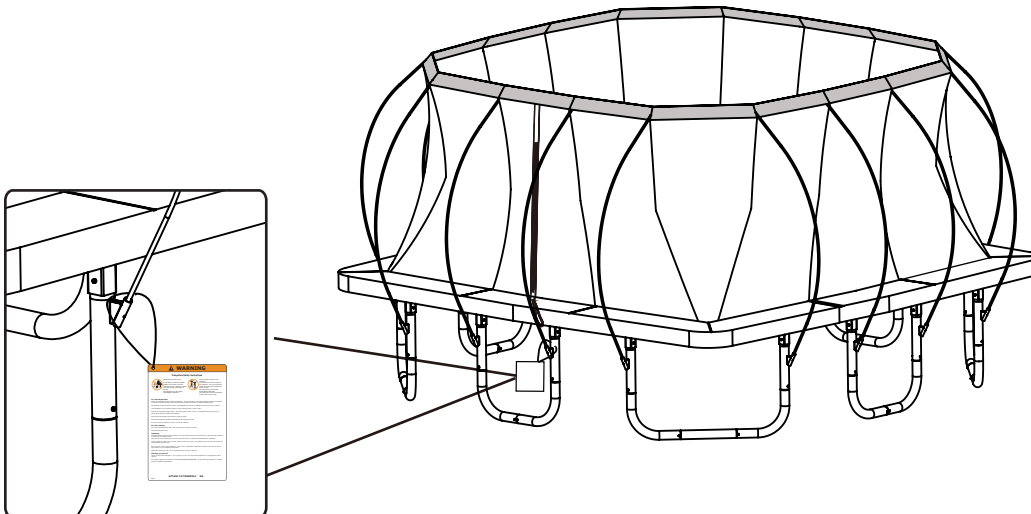

STEP 27

Congratulations on completing your new trampoline! (See, we knew you could do it!) So here comes the real question, are you satisfied with this completed product? If you are, go ahead and write a review on the retailer's site you bought it from. We'd really appreciate it, and if we could, we'd give you a gold star. Are you completely frustrated and have some choice words for us? Contact us directly! We're not trying to ruin your life, we promise. And we'll do everything we can to make it right again. See contact info on page 2-3.

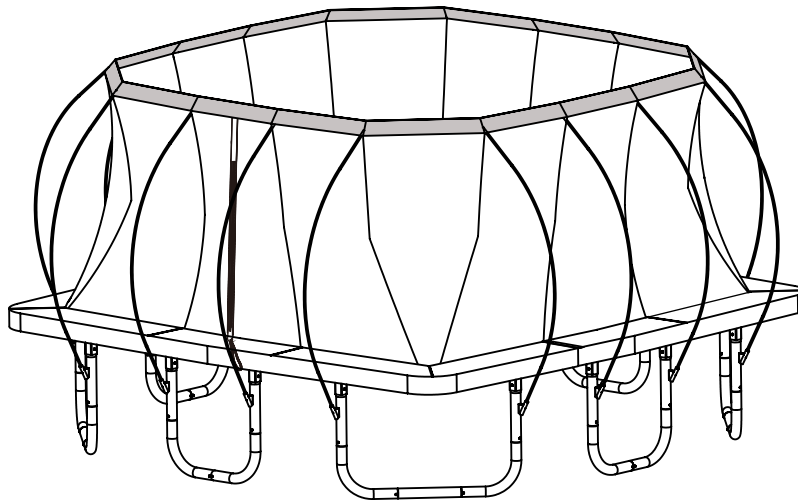

MAINTENANCE & CARE INFORMATION

Congratulations and **high five** on successfully assembling your new Skywalker Trampolines 15' Square Premium Trampoline with Enclosure! Now, the best way to keep your new trampoline in tip top shape, is to periodically check for:

- Missing, improperly positioned, or insecurely attached frame padding, netting, or enclosure rods
- Punctures, frays, tears, or holes worn in the mat, frame padding, netting, straps, or sleeves
- Deterioration in the stitching or fabric of the mat, frame padding or netting
- Ruptured or missing springs
- Bent or broken frame, leg or enclosure rods
- Sagging bed or netting
- Sharp protrusions on the frame, suspension system or enclosure rods

If you notice any of the above conditions, please disassemble the trampoline and/or the enclosure net until new parts are ordered!

Moving the Trampoline and Enclosure

If you need to move this trampoline, it will take 4-6 adults, kept horizontal and lifted slightly. If necessary, the trampoline and enclosure can be taken apart for moving. To take the trampoline apart, follow the assembly steps in reverse order. Do not attempt to take the frame sections, legs, or bases apart before the mat and springs have been removed.

Don't forget to check us out online! **We'd love to hear from you.**



@skywalkertrampolines



skywalkertrampolines



@skywalker_trampolines



@swtrampolines



@swtrampolines



www.skywalkertrampolines.com



@skywalkertrampolines

INSTRUCTIONS FOR USE

To reduce the risk of serious injury, read and follow all of the warnings, precautions, and instructions in this manual before you use the trampoline enclosure. Warnings and instructions for care, maintenance, and use of this trampoline and enclosure are included to promote safe enjoyable use of this equipment.

1. It is the responsibility of the owner and supervisors of the trampoline and enclosure to make sure all users obey the safety instructions given in this manual. The trampoline should only be used with mature, knowledgeable supervision.
2. Secure the trampoline and trampoline enclosure against unauthorized and unsupervised use. If you use a ladder to get on and off the trampoline, be sure to remove it when the trampoline and enclosure are not being used.
3. Be sure there is enough clear space above the trampoline and enclosure before use. It is best to have at least 24 feet (7.3 meters) of clear space above the ground. This space must be clear of wires, tree limbs, and any other possible hazards.
4. Lateral (sideways) clearance is very important. Do not place the trampoline and enclosure near walls, buildings, fences, sidewalks, and other play areas. Always keep a clear space on all sides of the trampoline and enclosure.
5. Remove any objects that could interfere with the performer. Maintain a clear area around and under the trampoline.
6. Be sure the trampoline and enclosure are on a level surface before use.
7. Always inspect the trampoline and enclosure before each use. Make sure that the frame, padding, netting, enclosure tubes, and foam sleeves are correctly and securely positioned. Replace any worn, defective, or missing parts. (Jumpers may be hurt if the trampoline and enclosure are used when they are in poor condition.)
8. Bounce only when the surface of the mat (bed) is dry. There should be very little or no wind or air movement. The trampoline and enclosure must not be used in gusty or severe winds.
9. The trampoline and enclosure frames are made of metal. They are not grounded and will conduct electricity. For this reason, an electrocution hazard exists. No lights, electric heaters, extension cords, or household electrical appliances are to be permitted on the trampoline or in enclosure at any time.
10. Use the trampoline and enclosure in an area with lots of light. If the trampoline and enclosure are indoors or in shady areas, you may need to use artificial (electrical) lighting in the area.
11. During the winter months, the trampoline soft materials will need to be removed and stored in a dry place. If left up in the winter months, it may cause damage to the springs, jump mat, spring pad, and enclosure. The warranty will be void.
12. This trampoline and enclosure is made for users who weigh less than 600 lbs.
13. Trampoline over 20 in. (51 cm) tall are not recommended for use by children under 6 years of age.
14. The trampoline enclosure is to be used only with the size of trampoline for which the enclosure is designed.
15. Misuse and abuse of the trampoline enclosure is dangerous and can cause serious injury.
16. Do not attach anything to the enclosure barrier that is not a manufacturer-approved accessory or part of the enclosure system.
17. Please remove any jewelry before jumping begins. Jewelry may get caught in the enclosure netting.
18. Wear clothing free of drawstrings, hooks, loops, or anything that could be caught while using the trampoline/enclosure and result in entanglement, strangulation, or both.
19. DO NOT let more than one person inside the trampoline enclosure at the same time. Two or more people jumping at the same time can cause serious injury.
20. DO NOT jump on the trampoline while you have or are holding any objects, especially something sharp or breakable.
21. DO NOT use the trampoline and enclosure if you have been using alcohol or drugs.
22. DO NOT attempt or allow somersaults (flips) on the trampoline. Landing on the head or neck can cause serious injury, paralysis, or death, even when landing in the middle of the jumping mat.
23. Always climb on to and off of the trampoline. It is a dangerous practice to jump from the trampoline to the floor or ground when dismounting, or to jump onto the trampoline when mounting.
24. DO NOT use the trampoline as a springboard to other objects. Enter and exit the enclosure only at the enclosure door or barrier made for that purpose.
25. DO NOT attempt to crawl under, jump over, intentionally bounce off of, hang from, climb on, kick, or cut the barrier netting.
26. While keeping head erect, focus eyes on the trampoline toward the perimeter. This will help control bounce.
27. Stop bouncing by flexing knees as feet come in contact with the trampoline bed. Learn this skill before attempting others.
28. Avoid bouncing too high. Stay low until bounce control and repeated landings in the center of the trampoline can be accomplished. Control is more important than height.
29. Avoid bouncing when tired. Keep turns short.
30. Learn fundamental bounces and body positions thoroughly before trying more advanced skills. A variety of trampoline activities can be carried out performing the basic fundamentals in various series and combinations, performing one fundamental after another, with feet bounces between them.
31. For additional information concerning the trampoline equipment contact the manufacturer. For information concerning skill training, contact a certified trampoline instructor.
32. Do not use or stand near the trampoline in windy or gusty conditions. A trampoline can become airborne when exposed to sustained wind or gusting wind conditions. This can result in serious injury, paralysis, or death, as well as property damage. To reduce these risks, disassemble the trampoline and enclosure and store them until weather conditions improve. Anchoring a trampoline frame may prevent the trampoline from moving as a result of the wind, but even anchored trampolines can become airborne or damaged. Consult a qualified contractor to determine what type of anchor works best in your location.

WARNING LABEL PLACEMENT

WARNING



Do not land on head or neck. Do not attempt or allow somersaults. Landing on your head or neck can cause serious injury, paralysis, or death, even when landing in the middle of the mat. Use trampoline only with mature, knowledgeable supervision.



Only one person at a time on the trampoline. Do not allow more than one person on the trampoline. Use by more than one person at the same time increases the chance of injury. Use trampoline only with mature, knowledgeable supervision. This trampoline is not recommended for children under 6 years of age.

For the Supervisor:
Read the instructions before using the trampoline. Enforce all of the safety rules and be familiar with the information in the User Manual to help new users learn basic jumps and all users to follow trampoline safety.

All trampoline users must have mature, knowledgeable supervision, regardless of the skill or age of the jumper.

This trampoline is not recommended for use by children under 6 years of age.

Inspect the trampoline before using. Keep frame pad in place. A worn or damaged mat (bed), spring, or frame piece should be replaced immediately.

Keep objects away that could interfere with the jumper.

Secure the trampoline against unauthorized and unsupervised use.

Do not use when trampoline is wet or in a windy condition.

For the Jumper:
Do not use the trampoline when under the influence of drugs or alcohol.

Avoid bouncing when tired.

Jumping:
Learn the basic jumps and body positions very well before trying more difficult stunts. Study the User Manual to learn how to do basic jumps.

Stop your bounce by flexing your knees as your feet come in contact with the trampoline mat (bed).

Avoid jumping too high or for too long. Always control your jump. A controlled jump is one where the take of and land spots are the same.

Bounce in the center of the trampoline. Focus eyes on trampoline toward the perimeter mat. Failure to do so may result in a loss of balance and control.

Take turns jumping one at a time, and always have someone watch you.

Getting on and off:
Climb on to and off the trampoline. Do not jump on or off. Do not use the trampoline as a springboard to other objects.

For further equipment information contact Skywalker. For skill training information, contact a trainer certification organization.

ATTACH TO TRAMPOLINE

WARNING



Do not land on head or neck. Do not attempt or allow somersaults. Landing on your head or neck can cause serious injury, paralysis, or death, even when landing in the middle of the mat.



Use trampoline only with mature, knowledgeable supervision. Do not allow more than one person at the same time increases the chance of injury. Use trampoline only with mature, knowledgeable supervision. This trampoline is not recommended for children under 6 years of age.

WARNING



Do not attempt or allow somersaults (Flips)

Do not land on head or neck. Landing on your head or neck can cause serious injury, paralysis, or death, even when landing in the middle of the mat.



Use trampoline only with mature, knowledgeable supervision.

Do not allow more than one person on the trampoline. Multiple jumpers increase the chance of loss of control, collision and falling off. This can result in broken head, neck, back, or legs.

Use Trampoline only with mature, knowledgeable supervision.

This trampoline is not recommended for children under 6 years of age.

Read all of the instructions before using this trampoline.

Inspect before using and replace any worn, defective or missing parts.

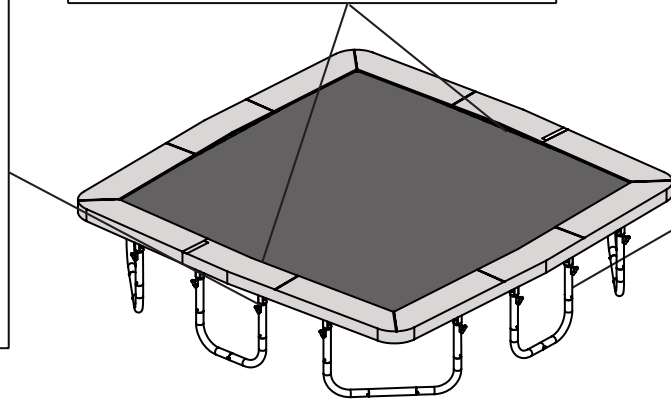

WARNING



Do not land on head or neck. Do not land on head or neck. Paralysis or death can result, even if you land in the middle of the trampoline mat (bed). Do not do somersaults (flips). Use trampoline enclosure only with mature, knowledgeable supervision. Enforce all safety rules and be familiar with the information in the User's manual to help users in following enclosure instructions and trampolines safety.



Only one person at a time on the trampoline. Multiple jumpers increase the chance of loss of control and this can result in broken head, back or leg. Users may become entangled in or strangled by loose cards or gaps between trampoline and enclosure.

For the Supervisor:
Use trampoline enclosure only with mature, knowledgeable supervision. Enforce all safety rules and be familiar with the information in the users manual to help users in following trampoline enclosure instructions and trampoline safety.

This trampoline enclosure system is not recommended for use by children under 6 years of age.

Do not exceed the weight limit recommended by the manufacturer.

Use only when the trampoline mat (bed) is clean and dry. Inspect the trampoline and enclosure prior to each use and replace any worn or damaged parts.

Use only when enclosure barrier has no holes, pole clamps are tightly secured to the poles, and the support (frame) and the barrier is properly suspended.

For the Jumper:
Do not use the trampoline when under the influence of drugs or alcohol.

Jumping:
Avoid jumping too high for too long. Always control your jump. Do not try to jump over the barrier.

Do not intentionally rebound of the barrier. Do not hang from, kick, out or climb on the barrier.

Wear clothing free of drawstrings, hooks, loops, or anything that could get caught while using the trampoline/ enclosure and result in entanglement or stranglement or both.

Getting on and off:
Climb on to and off the trampoline at the enclosure door or barrier opening. Do not jump on or off. Do not crawl under the barrier. Do not use the trampoline as a springboard to other objects.

Do not jump from other objects, buildings, or surfaces, onto the trampoline, or into or over the trampoline enclosure.

For further equipment information contact Skywalker Trampolines. For skill training information, contact a trainer certification organization.

ATTACH TO NETTING AT DOOR

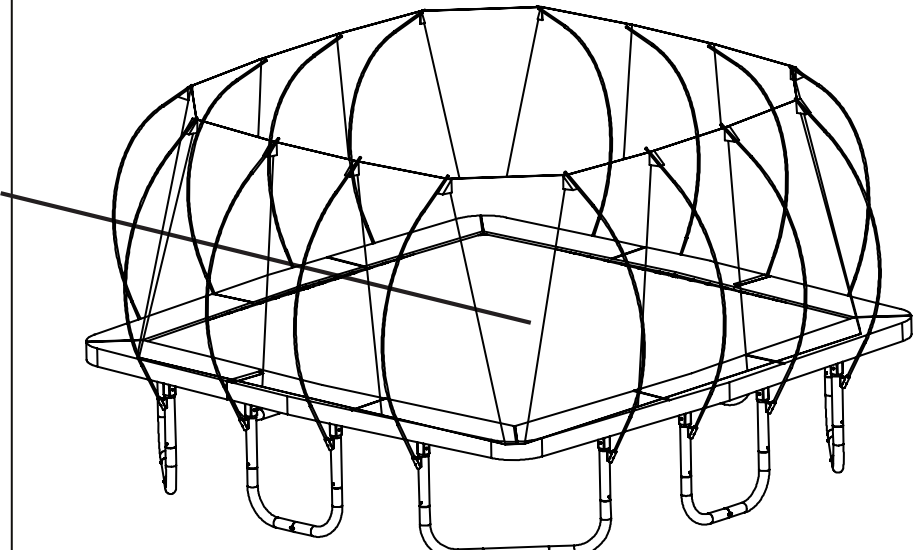

The placard shown above was sewn to the trampoline enclosure netting.

Note: The labels and placard shown are not actual size.

The labels shown on this page have been attached to the trampoline in the indicated locations. The safety instructions placard will need to be attached by the owner. If one of the labels or the placard is missing or illegible, call our Customer Care Hot Line toll-free at 1-866-603-JUMP (5867) to order a free replacement label or placard.

INSTRUCTIONS & MODEL LESSONS

The following lessons are examples of an instructional program. They should follow a complete discussion and demonstration of body mechanics between the supervision and the student(s).

1. Fundamental bounce: Demonstration and practice.
2. Knee Drop: Demonstration and practice.
3. Hand and Knee Drop: Demonstration and practice, stressing four-point landing and alignment.
4. Back Drop: Demonstration and practice.
5. Seat Drop: Demonstration and practice.
6. Front Drop: Demonstration and practice.
7. Half Turntable: Demonstration and practice.
8. Swivel Hips: Demonstration and practice.
9. Mounting and dismounting: Demonstration and practice of proper techniques.
10. Breaking: Demonstration and practice. Breaking on command.

Lesson 1: Fundamental Bounce

1. Start from a standing position with your head erect and your eyes on the frame pad.
2. Swing your arms forward and up in a circular motion.
3. Bring your feet together and point your toes downward while in the air.
4. Keep your feet about 15 inches apart when landing on the mat.

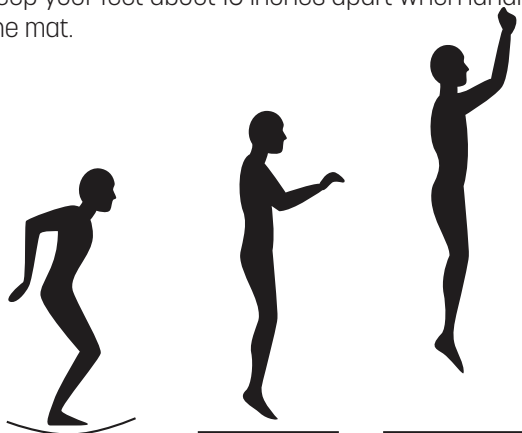

Lesson 2: Knee Drop

1. Start bouncing from a standing position, keeping your eyes on the frame pad.
2. Land on your knees, keeping your back straight and your body erect.
3. Come back up to an erect position.

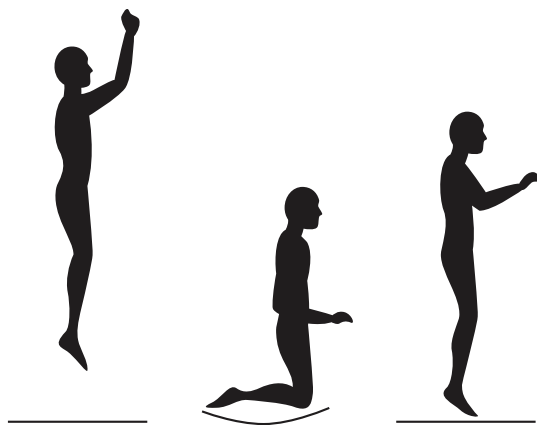

Lesson 3: Hand and Knee Drop

1. Start bouncing from a standing position, keeping your eyes on the frame pad.
2. Land on the mat on your hands and knees.
3. Push with your hands and come back up to an erect position.

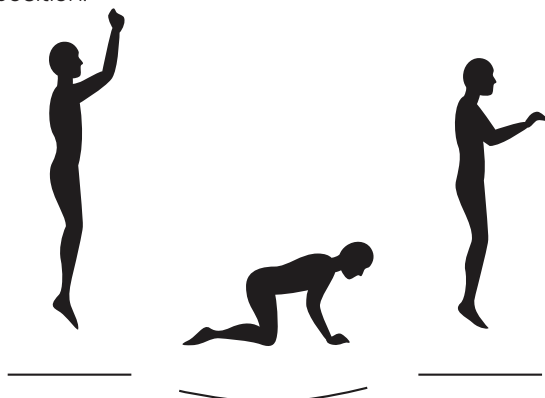

Lesson 4: Back Drop

1. Start from a low bounce and land on your back.
2. Keep your chin forward on your chest as you land.
3. Kick forward and up with your legs to return to an erect position.

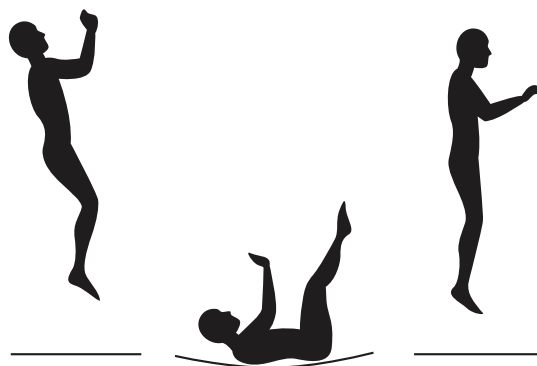

Lesson 5: Seat Drop

1. Land in a sitting position with your legs parallel to the mat.
2. Place your hands on the mat beside your hips.
3. Push with your hands to return to an erect position.

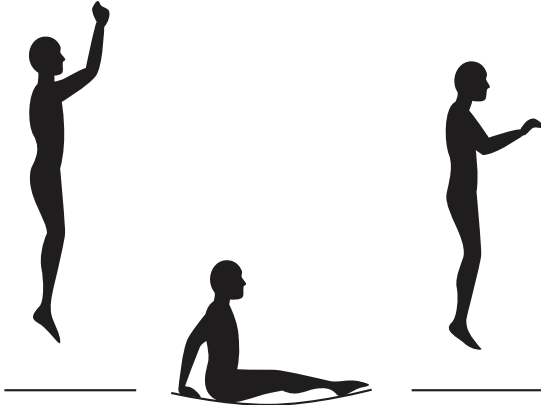

Lesson 6: Front Drop

1. Start from a low bounce and land on the mat in a prone position.
2. Keep your head up and your arms extended forward on the mat.
3. Push with your arms to return to an erect position.

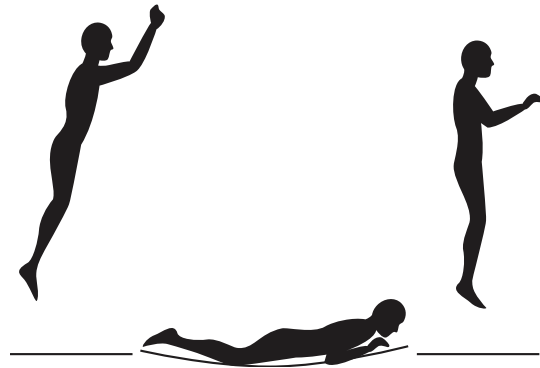

Lesson 7: Half Turntable

1. Start from the front drop position and push to the left or right with your arms turning your body in the opposite direction.
2. Turn your head and shoulders toward the direction that your body is turning.
3. Keep your back parallel to the mat and your head up.
4. After completing a half turn, land in the front drop position.

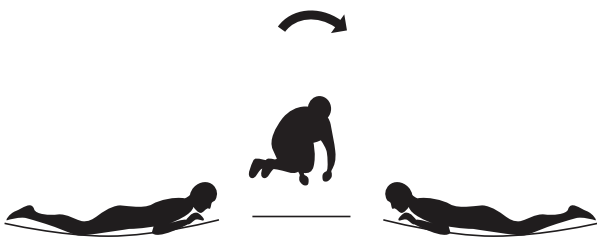

Lesson 8: Swivel Hips

1. Start with a seat drop.
2. Turn your head to the left or right and swing your arms up in the same direction.
3. Turn your hips in the same direction as your head and arms, completing a twist.
4. Land in the seat drop position.
5. Keep your legs parallel to the mat and your head up.
6. After completing a half turn, land in the front drop position.



Lesson 9: Mounting and Dismounting

1. Users should climb onto the trampoline by placing their hands on the frame and stepping or rolling up onto the frame, across the springs and onto the mat.
2. To dismount, jumpers should walk to the side of the mat, bend over and place their hands on the frame, then step from the mat to the ground.

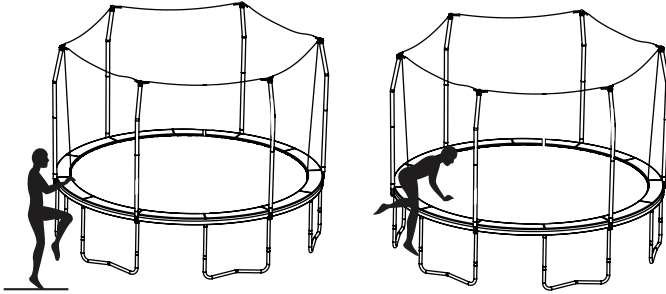

Lesson 10: Breaking

1. Starting from a standing position, jump into the air.
2. As you land on the mat, bend your knees sharply to stop the jump.



Once each of these lessons are learned, the student should now be encouraged to design and organize routines, with emphasis on good form. The instructor may judge or grade students and arrange groupings for further instruction accordingly.

To stimulate interest in competition, the game of "Trampoline Horse" can be introduced. Before the game begins, students must count off. To start the game, student number 1 performs a stunt then dismounts. Student number 2 then mounts the trampoline, performs the same stunt and adds a second stunt, then dismounts. Student number 3 mounts and performs stunts 1 and 2 and adds a third stunt, then dismounts. Thus the series of stunts is continuously lengthened. The first person to miss a stunt in the series assumes the letter "H" and starts a new series with a stunt. If a person misses again, he assumes the letter "O." When a person accumulates "H-O-R-S-E," he or she is eliminated from the game. The last remaining contestant is the winner. Lesson planning from this point on should be facilitated by contacting a certified trampoline instructor.

TRAMPOLINE SAFETY INFORMATION

In trampoline use, as in all active recreational sports, participants can be injured. However, there are steps that can be taken to reduce risk of injury. In this section, primary accident patterns are identified and the responsibilities of supervisors and jumpers in accident prevention are described.

ACCIDENT CLASSIFICATION

Somersaults (flips): Landing on your head or neck, even in the middle of the trampoline mat, increases the risk of a broken back or neck, which can result in paralysis or death. Such events can occur when a jumper makes an error trying to perform a forward or backward somersault (flip). Do not perform somersaults(flips) on this backyard trampoline.

Multiple Jumpers: More than one jumper at a time on the trampoline increases the chance of a jumper becoming injured by losing control of his or her jump. Jumpers may collide with one another, fall off of the trampoline, fall onto or through the springs, or land incorrectly on the mat. The jumper weighing the least is the jumper most likely to be injured.

Mounting and Dismounting (Getting on and off): The trampoline mat is several feet above ground level. Jumping from the trampoline to the ground or any other surface may result in injury. Jumping onto the trampoline from a roof, deck, or other objects also presents a risk of injury. Smaller children may need assistance getting onto or down from the trampoline. Climb carefully onto and off of the trampoline. Do not step onto the springs or the frame pad. Do not grasp the frame pad to pull yourself onto the trampoline.

Striking the Frame or the Springs: Injury may result from hitting the frame or falling through the springs while jumping or getting onto or off of the trampoline. Stay in the center of the mat when jumping. Be sure to keep the frame pad in place to cover the frame. The frame pad is not made or intended to support the weight of the trampoline user. Do not step or jump directly on the frame pad.

Loss of Control: Jumpers who lose control of their jumps may land on the mat incorrectly, land on the frame or springs, or fall off of the trampoline. A controlled jump is one where the landing is in the same spot as the takeoff. Before learning a more difficult stunt, you should be able to do one over and over with control. Attempting a stunt beyond present skill levels increases the chance of loss of control. To regain control and stop your jump, bend your knees sharply when you land.

Alcohol or Drug Use: The chance of injury increases when a jumper has consumed alcohol or taken drugs. These substances impair a person's reaction time, judgment, and physical coordination.

Encountering Objects: Jumping on a trampoline while other people, pets, or objects are underneath it will increase the chance of getting hurt. Jumping while holding or having an object on the trampoline, particularly one that is sharp or breakable, will increase the chance of injury. Placing a trampoline too close to overhead electrical wires, tree limbs, or other objects can increase the chance of injury.

Poor Maintenance of the Trampoline: Jumpers may be injured if a trampoline is in poor condition. A torn mat, bent frame, broken spring, or missing frame pad, for example, should be replaced before anyone is allowed to jump. Inspect the trampoline before each use.

Weather Conditions: A wet trampoline is too slippery for safe jumping. Gusty or high winds can cause jumpers to lose control. To reduce the chance of injury, use the trampoline only when the weather is good.

Access: To prevent access to the trampoline by unsupervised smaller children, the optional access ladder should always be taken away and stored in a safe place when the trampoline is not in use.

ENCLOSURE SAFETY INFORMATION

NEED FOR TRAMPOLINE ENCLOSURE SAFETY

A trampoline enclosure is a recreational product. The information on this page identifies important safety precautions. The precautions are not all-inclusive, because an enclosure can be used in ways that this manual cannot cover completely.

To prevent pinches and cuts during enclosure use, a frame pad must be installed on the trampoline (see the trampoline manufacturer's instructions). The frame pad must be placed on the trampoline before the enclosure is erected. The frame pad reduces the chance of injury from accidental contact with the springs and frame.

USING THE ENCLOSURE SAFELY

Adult Supervision of Children

Children using a trampoline with a trampoline enclosure must be supervised by adults. Young children must be supervised constantly. Adults must pay particular attention to:

- Things that children bring into the enclosure
- Children's activities inside the enclosure
- Conditions inside the enclosure while children are using it
- The way children enter and exit the enclosure

Additional details of safety enclosure use are described below:

Electrocution Hazard Associated with the Metal Frame of the Trampoline and Enclosure

The trampoline and enclosure frames are made of galvanized steel. They are not grounded and will conduct electricity. For this reason, an electrocution hazard exists. No lights, electric heaters, extension cords, or household electrical appliances are to be permitted on the trampoline or in the enclosure at any time.

Hazards Associated with Entering and Exiting the Trampoline Enclosure

A trampoline enclosure installed on a trampoline is raised off the ground. The height of the enclosure increases the risk of a fall when a jumper is entering or leaving the enclosure. Young children especially may have difficulty entering and exiting the enclosure. To reduce the risk of falling, always help young children to get into and out of the enclosure.

Enter and exit the trampoline enclosure only through the door of the enclosure (the opening in the netting walls). The trampoline mat (bed) and the netting walls of the enclosure are separate pieces. No jumper, especially young children, should ever leave the enclosure by going out between the mat and the netting walls. Trying to get out this way creates a risk of choking from being caught between the trampoline frame and the netting walls.

Darkness increases the chances of a fall when a jumper is entering or leaving the enclosure. Do not use the trampoline unless there is plenty of lighting provided.

Hazards Associated with Animals, Sharp or Breakable Objects

To avoid damage to the trampoline enclosure and the trampoline, do not allow pets or other animals inside of the enclosure. The claws and teeth of animals can damage the netting. Do not jump on the trampoline while holding or wearing a sharp or breakable object.

METHODS OF ACCIDENT PREVENTION

THE SUPERVISOR'S ROLE IN PREVENTING ACCIDENTS

It is the responsibility of the supervisors of trampoline users to provide knowledgeable and mature supervision. They need to know and enforce all of the rules and warnings printed in this manual to minimize the likelihood of accidents and injuries. They also need to inform users of these rules. During periods of time when supervision is unavailable or inadequate, this may require that the trampoline is taken down, placed in a secure area, or otherwise secured against unauthorized use. Another option that may be considered is covering the trampoline with a heavy tarp that can be secured with locks and chains. It is the responsibility of the supervisor to make sure that the placard with trampoline safety instructions is kept posted on the trampoline and that jumpers are informed about these instructions.

THE JUMPER'S ROLE IN PREVENTING ACCIDENTS

Education on the part of the user is a must for safety. Users must first learn a low, controlled bounce and then learn the basic landing positions and combinations before proceeding to intermediate skills. Jumpers must understand why they have to master "control" before they can start thinking about other moves. Understanding the proper progression of skills in jumping on a trampoline must be the first lesson. Review this manual to learn about the basic techniques for using the trampoline. Follow the rules on the placard with trampoline safety instructions (see step [25] in assembly instructions). For further information or additional instructional materials, contact a certified trampoline instructor.

TRAMPOLINE SAFETY INSTRUCTIONS

For the Supervisor

Read the instructions before using the trampoline. Enforce all of the safety rules. Become familiar with the information in this manual so you can help new users learn basic jumps and all users follow trampoline safety. All trampoline users must have mature, knowledgeable supervision, regardless of their skill or age. This trampoline is not recommended for use by children under 6 years of age. Inspect the trampoline before using it. Do not use the trampoline without the frame pad securely in place to cover the frame. Do not use the trampoline in wet or windy conditions. A worn or damaged mat, spring, or frame piece should be replaced immediately.

Jumping

Learn fundamental jumps and body positions thoroughly before trying more advanced skills. Know your own limits in performing each of the trampoline jumps. Study this manual to learn how to do basic jumps. Stop your bounce by flexing your knees as your feet come in contact with the trampoline mat. Learn this skill before attempting any others.

HAZARDS ASSOCIATED WITH HIGH WINDS

A trampoline with an enclosure can be moved or blown over by high winds. Anyone in its path, or inside of the enclosure, may be injured if this happens. If you expect high winds, take down the enclosure netting and stake the trampoline frame to the ground, or move the trampoline and enclosure to a sheltered location. The only sure method to protect your trampoline and the surrounding environment during high winds is to completely disassemble the unit and store indoors. Damage due to wind or weather is not warranted.

LIMITED WARRANTY

Skywalker Holdings, LLC warrants its products to be free from defects in material and workmanship under normal use and service conditions. **The steel frame is warranted for ten (10) years after the date of purchase. All other parts are warranted for two (2) years after the date of purchase.** Warranty coverage extends only to the original retail purchaser from the date of original purchase. This warranty is only valid concerning products used for residential use. Products used for commercial use, such as schools and daycares, will not be covered.

WHAT IS NOT COVERED?



Weather Damage: The warranty does not cover damage due to the effects or acts of nature, such as earthquakes, wind, hurricanes, tornadoes, lightning, rain, fire, snow, excessive heat and cold conditions and/or sun damage. During the winter months the trampoline soft materials will need to be removed and stored in a dry place out of the snow. If left unprotected in the winter months, some components such as springs, jump mat, spring pad and enclosure, may become damaged, voiding this warranty.



Fading and Rust: Our products are fully galvanized. Skywalker does not warranty against rust or corrosion. Some areas may have higher air salt content, higher humidity, heavier rain and heavier snow. Skywalker does not warranty against fading. We suggest customers use a UV protectant on the frame pad to extend the life of the product.



Loss or damage to Product: Loss or damage caused during shipping or caused by abuse, misuse, improper or abnormal usage or unauthorized repair are not covered by this warranty and may also void the warranty.



Unauthorized Replacement Parts: The warranty will become void if any defects or damages are associated with the use of unauthorized replacement parts. All replacement parts must be obtained from an authorized agent.



Assembly Service: The warranty does not cover acts or omissions provided by a third-party assembly service. It is the customer's responsibility to check all boxes and confirm all components are included and in their proper condition before installation occurs.

INSPECTION AND REPLACEMENT PARTS:

1. Your trampoline SHOULD BE INSPECTED UPON UNPACKING AND SET UP AND THEREAFTER ON A REGULAR BASIS. WORN, DAMAGED OR BROKEN PARTS SHOULD BE REPLACED IMMEDIATELY AND BEFORE USE.
2. Call the Skywalker Trampolines Customer Service Department at 1-866-603-5867 to file a warranty claim. Be prepared to provide the following information: name, shipping address, a copy of your original sales receipt, a brief description of the problem and cause, trampoline model number and serial number. We may also ask for photos of the damaged/defective parts.
3. After reviewing your information and examining your photos, Skywalker Trampolines will make the determination if this part is covered by this warranty. If so, a replacement part will be sent to you.

NOTE: All requested information must be provided in order to review your warranty claim.

To order replacement parts for your product please visit www.skywalkertrampolines.com

Skywalker Holdings, LLC, PO Box 574, Brigham City, UT 84302 USA.

Printed in the USA © 2022 Skywalker Holdings, LLC

NOTE: SKYWALKER HOLDINGS, LLC IS NOT RESPONSIBLE OR LIABLE FOR INDIRECT, SPECIAL OR CONSEQUENTIAL DAMAGES ARISING OUT OF OR IN CONNECTION WITH THE USE OR PERFORMANCE OF THE PRODUCT OR OTHER DAMAGES WITH RESPECT TO ANY ECONOMIC LOSS, LOSS OF PROPERTY, LOSS OF REVENUE OR PROFITS, LOSS OF ENJOYMENT OR USE, COST OF REMOVAL, INSTALLATION OR OTHER CONSEQUENTIAL DAMAGES. SOME STATES DO NOT ALLOW THE EXCLUSION OR LIMITATION OF INCIDENTAL OR CONSEQUENTIAL DAMAGES. ACCORDINGLY, THE ABOVE LIMITATION MAY NOT APPLY TO YOU.

THE WARRANTY EXTENDED HEREUNDER IS IN LIEU OF ALL OTHER WARRANTIES AND ANY IMPLIED WARRANTY OF MERCHANTABILITY OR FITNESS FOR A PARTICULAR PURPOSE IS LIMITED IN ITS SCOPE AND DURATION TO THE TERMS SET FORTH HEREIN. SOME STATES OR COUNTRIES DO NOT ALLOW LIMITATIONS ON HOW LONG AN IMPLIED WARRANTY LASTS. ACCORDINGLY, THE ABOVE LIMITATION MAY NOT APPLY TO YOU. THIS WARRANTY GIVES YOU SPECIFIC LEGAL RIGHTS. YOU MAY ALSO HAVE OTHER RIGHTS WHICH VARY STATE TO STATE OR COUNTRY TO COUNTRY.

THIS WARRANTY IS VALID ONLY IN THE COUNTRY THE PRODUCT WAS PURCHASED.